



Winstar Display Co., LTD



SPECIFICATION

CUSTOMER : _____

MODULE NO.: WH1601A-XXX-XX

<p style="text-align: center;">APPROVED BY:</p> <p>(FOR CUSTOMER USE ONLY)</p>	
---	--

SALES BY	APPROVED BY	CHECKED BY	PREPARED BY
ISSUED DATE:			



MODLE NO

RECORDS OF REVISION			DOC. FIRST ISSUE
VERSION	DATE	REVISED PAGE NO.	SUMMARY
0	2004.03.29		First issue

Contents

- 1.Module Classification Information
- 2.Precautions in use of LCD Modules
- 3.General Specification
- 4.Absolute Maximum Ratings
- 5.Electrical Characteristics
- 6.Optical Characteristics
- 7.Interface Pin Function
- 8.Contour Drawing & Block Diagram
- 9.Function Description
- 10.Character Generator ROM Pattern
- 11.Instruction Table
- 12.Timing Characteristics
- 13.Initializing of LCM
- 14.Quality Assurance
- 15.Reliability
- 16.Backlight Information

1.Module Classification Information

W H 1 6 0 1 A - Y G B - ST
 ① ② ③ ④ ⑤ ⑥ ⑦ ⑧

① Brand : WINSTAR DISPLAY CORPORATION

② Display Type : H→Character Type, G→Graphic Type

③ Display Font : Character 16 words, 1Lines.

④ Model serials no.

⑤ Backlight Type : N→Without backlight

B→EL, Blue green A→LED, Amber

D→EL, Green R→LED, Red

W→EL, White O→LED, Orange

F→CCFL, White G→LED, Green

Y→LED, Yellow Green

⑥ LCD Mode : B→TN Positive, Gray T→FSTN Negative

N→TN Negative,

G→STN Positive, Gray

Y→STN Positive, Yellow Green

M→STN Negative, Blue

F→FSTN Positive

⑦ LCD Polarizer Type/ Temperature range/ View direction A→Reflective, N.T, 6:00 H→Transflective, W.T,6:00

D→Reflective, N.T, 12:00 K→Transflective, W.T,12:00

G→Reflective, W. T, 6:00 C→Transmissive, N.T,6:00

J→Reflective, W. T, 12:00 F→Transmissive, N.T,12:00

B→Transflective, N.T,6:00 I→Transmissive, W. T, 6:00

E→Transflective, N.T.12:00 L→Transmissive, W.T,12:00

⑧ Special Code ST : English and European standard font

2.Precautions in use of LCD Modules

- (1) Avoid applying excessive shocks to the module or making any alterations or modifications to it.
- (2) Don't make extra holes on the printed circuit board, modify its shape or change the components of LCD module.
- (3) Don't disassemble the LCM.
- (4) Don't operate it above the absolute maximum rating.
- (5) Don't drop, bend or twist LCM.
- (6) Soldering: only to the I/O terminals.
- (7) Storage: please storage in anti-static electricity container and clean environment.

3.General Specification

Item	Dimension	Unit
Number of Characters	16 characters x 1 Lines	—
Module dimension	80.0 x 36.0 x 13.2(MAX)	mm
View area	66.0 x 16.0	mm
Active area	59.62 x 6.56	mm
Dot size	0.55 x 0.75	mm
Dot pitch	0.63 x 0.83	mm
Character size	3.07 x 6.56	mm
Character pitch	3.77 x 6.56	mm
LCD type	STN, Positive, Transflective, Gray	

Duty	1/16
View direction	6 o'clock
Backlight Type	LED Yellow Green

4. Absolute Maximum Ratings

Item	Symbol	Min	Typ	Max	Unit
Operating Temperature	T_{OP}	0	—	+50	°C
Storage Temperature	T_{ST}	-10	—	+60	°C
Input Voltage	V_I	V_{SS}	—	V_{DD}	V
Supply Voltage For Logic	$V_{DD}-V_{SS}$	-0.3	—	7	V
Supply Voltage For LCD	$V_{DD}-V_0$	-0.3	—	13	V

5. Electrical Characteristics

Item	Symbol	Condition	Min	Typ	Max	Unit
Supply Voltage For Logic	$V_{DD}-V_{SS}$	—	4.5	—	5.5	V
Supply Voltage For LCD	$V_{DD}-V_0$	$T_a=0^{\circ}\text{C}$	—	—	4.8	V
		$T_a=25^{\circ}\text{C}$	—	4.5	—	V
			4.2	—	—	V

		Ta=50°C				
Input High Volt.	V _{IH}	—	2.2	—	V _{DD}	V
Input Low Volt.	V _{IL}	—	—	—	0.6	V
Output High Volt.	V _{OH}	—	2.4	—	—	V
Output Low Volt.	V _{OL}	—	—	—	0.4	V
Supply Current	I _{DD}	V _{DD} =5V	—	1.2	—	mA

6.Optical Characteristics

Item	Symbol	Condition	Min	Typ	Max	Unit
View Angle	(V)θ	CR≥ 2	20	—	40	deg
	(H)φ	CR≥ 2	-30	—	30	deg
Contrast Ratio	CR	—	—	3	—	—
Response Time	T rise	—	—	150	200	ms
	T fall	—	—	150	200	ms

Definition of Operation Voltage (Vop)

Definition of Response Time (Tr , Tf)

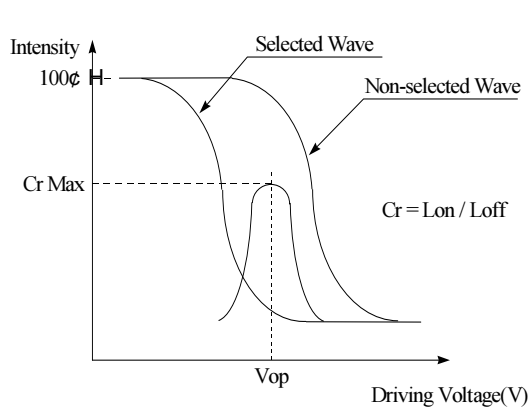

[positive type]

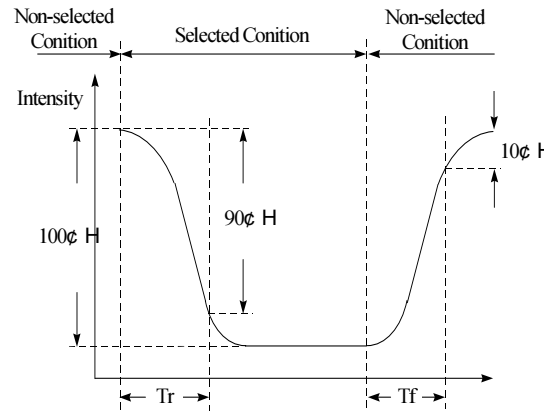

[positive type]

Conditions :

Operating Voltage : V_{op}

Viewing Angle(θ , ϕ) : 0° , 0°

Frame Frequency : 64 HZ

Driving Waveform : 1/N duty , 1/a bias

Definition of viewing angle($CR \geq 2$)

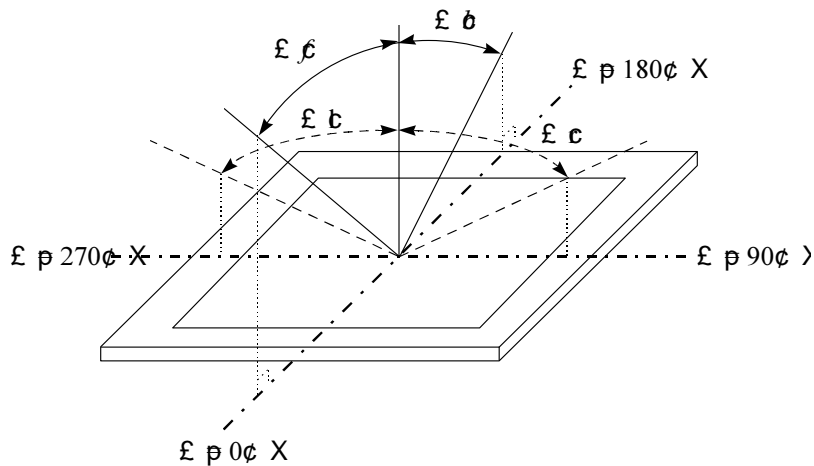

7.Interface Pin Function

Pin No.	Symbol	Level	Description
1	V_{SS}	0V	Ground
2	V_{DD}	5.0V	Supply Voltage for logic
3	VO	(Variable)	Operating voltage for LCD
4	RS	H/L	H: DATA, L: Instruction code
5	R/W	H/L	H: Read(MPU→Module) L: Write(MPU→Module)

6	E	H,H→L	Chip enable signal
7	DB0	H/L	Data bit 0
8	DB1	H/L	Data bit 1
9	DB2	H/L	Data bit 2
10	DB3	H/L	Data bit 3
11	DB4	H/L	Data bit 4
12	DB5	H/L	Data bit 5
13	DB6	H/L	Data bit 6
14	DB7	H/L	Data bit 7
15	A	–	LED +
16	K	–	LED –

8. Contour Drawing & Block Diagram

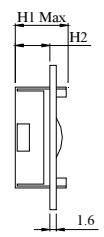
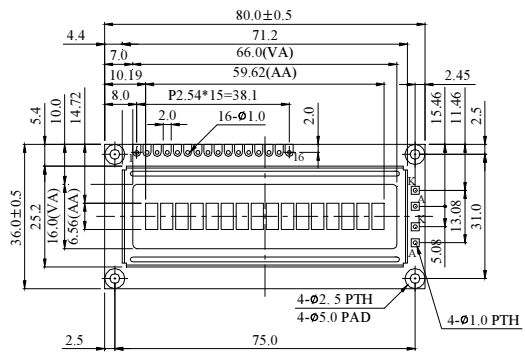

LED B/L

LED-H/L B/L	
	High Low
H1	13.2
H2	8.6

PIN NO.	SYMBOL
1	Vss
2	Vdd
3	Vo
4	RS
5	R/W
6	E
7	DB0
8	DB1
9	DB2
10	DB3
11	DB4
12	DB5
13	DB6
14	DB7
15	A/Vee
16	K

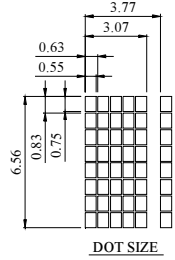

The non-specified tolerance of dimension is ±0.3mm.

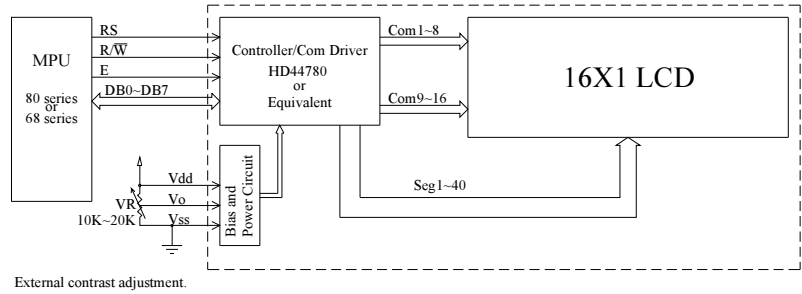

LED B/L Drive Method

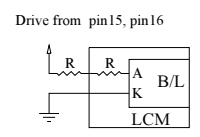

Character located	1	2	3	4	5	6	7	8	9	10	11	12	13	14	15	16
DDRAM address	00	01	02	03	04	05	06	07	40	41	42	43	44	45	46	47

2-line display mode.

9. Function Description

The LCD display Module is built in a LSI controller, the controller has two 8-bit registers, an instruction register (IR) and a data register (DR).

The IR stores instruction codes, such as display clear and cursor shift, and address information for display data RAM (DDRAM) and character generator (CGRAM). The IR can only be written from the MPU. The DR temporarily stores data to be written or read from DDRAM or CGRAM. When address information is written into the IR, then data is stored into the DR from DDRAM or CGRAM. By the register selector (RS) signal, these two registers can be selected.

RS	R/W	Operation
0	0	IR write as an internal operation (display clear, etc.)
0	1	Read busy flag (DB7) and address counter (DB0 to DB7)
1	0	Write data to DDRAM or CGRAM (DR to DDRAM or CGRAM)
1	1	Read data from DDRAM or CGRAM (DDRAM or CGRAM to DR)

Busy Flag (BF)

When the busy flag is 1, the controller LSI is in the internal operation mode, and the next instruction will not be accepted. When RS=0 and R/W=1, the busy flag is output to DB7. The next instruction must be written after ensuring that the busy flag is 0.

Address Counter (AC)

The address counter (AC) assigns addresses to both DDRAM and CGRAM

Display Data RAM (DDRAM)

This DDRAM is used to store the display data represented in 8-bit character codes. Its extended capacity is 80×8 bits or 80 characters. Below figure is the relationships between DDRAM

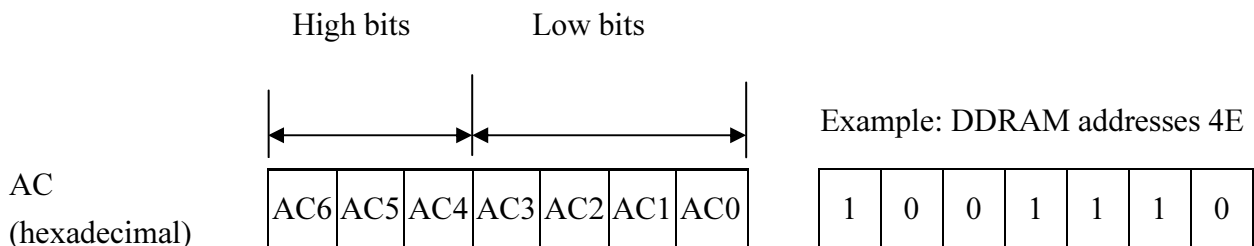

addresses and positions on the liquid crystal display.

Display position DDRAM address

1	2	3	4	5	6	7	8	9	10	11	12	13	14	15	16
00	01	02	03	04	05	06	07	08	09	0A	0B	0C	0D	0E	0F

1-Line by 16-Character Display

Character Generator ROM (CGROM)

The CGROM generate 5×8 dot or 5×10 dot character patterns from 8-bit character codes. See Table 2.

Character Generator RAM (CGRAM)

In CGRAM, the user can rewrite character by program. For 5×8 dots, eight character patterns can be written, and for 5×10 dots, four character patterns can be written.

Write into DDRAM the character code at the addresses shown as the left column of table 1. To show the character patterns stored in CGRAM.

Relationship between CGRAM Addresses, Character Codes (DDRAM) and Character patterns

Table 1.

For 5 * 8 dot character patterns

Character Codes (DDRAM data)		CGRAM Address		Character Patterns (CGRAM data)				
7 6 5 4 3 2 1 0		5 4 3 2 1 0		7 6 5 4 3 2 1 0				
High Low		High Low		High Low				
0 0 0 0 * 0 0 0		0 0 0	0 0 0	* * *		Character pattern(1)		
			0 0 1	* * *			0 0 0	Cursor pattern
			0 1 0	* * *			0 0 0	
			0 1 1	* * *			0 0 0	
			1 0 0	* * *			0 0 0	
			1 0 1	* * *			0 0 0	
			1 1 0	* * *			0 0 0	
			1 1 1	* * *			0 0 0	
			0 0 0	* * *			0 0 0	
			0 0 1	* * *			0 0 0	
0 0 0 0 * 0 0 1		0 0 1	1 0 0	* * *		Character pattern(2)		
			1 0 1	* * *			0 0 0	Cursor pattern
			1 1 0	* * *			0 0 0	
			1 1 1	* * *			0 0 0	
			0 0 0	* * *			0 0 0	
			0 0 1	* * *			0 0 0	
			0 1 0	* * *			0 0 0	
			0 1 1	* * *			0 0 0	
			1 0 0	* * *			0 0 0	
			1 0 1	* * *			0 0 0	
			0 0 0	* * *				
			0 0 1	* * *				

For 5 * 10 dot character patterns

Character Codes (DDRAM data)		CGRAM Address		Character Patterns (CGRAM data)				
7 6 5 4 3 2 1 0		5 4 3 2 1 0		7 6 5 4 3 2 1 0				
High Low		High Low		High Low				
0 0 0 0 * 0 0 0		0 0	0 0 0 0	* * *		Character pattern		
			0 0 0 1	* * *			0 0 0 0	Cursor pattern
			0 0 1 0	* * *			0 0 0	
			0 0 1 1	* * *			0 0 0	
			0 1 0 0	* * *			0 0 0	
			0 1 0 1	* * *			0 0 0	
			0 1 1 0	* * *			0 0 0	
			0 1 1 1	* * *			0 0 0	
			1 0 0 0	* * *			0 0 0	
			1 0 0 1	* * *			0 0 0	
			1 0 1 0	* * *	0 0 0 0 0			
			1 1 1 1	* * *	* * * * *			

■ : " High "

10.Character Generator ROM Pattern

Table.2

Upper 4 bit Lower 4 bit	LLLL	LLLH	LLHL	LLHH	LHLL	LHLH	LHHL	LHHH	HLLL	HLLH	HLHL	HLHH	HHLL	HHLH	HHHL	HHHH
LLLL	CG RAM (1)			0	1	2	3	4	5	6	7	8	9	:	;	;
LLLH	CG RAM (2)		!	!	!	!	!	!	!	!	!	!	!	!	!	!
LLHL	CG RAM (3)		"	2	3	4	5	6	7	8	9	0	:	;	;	;
LLHH	CG RAM (4)		*	3	4	5	6	7	8	9	0	1	2	3	4	5
LHLL	CG RAM (5)		\$	4	5	6	7	8	9	0	1	2	3	4	5	6
LHLH	CG RAM (6)		%	5	6	7	8	9	0	1	2	3	4	5	6	7
LHHL	CG RAM (7)		@	6	7	8	9	0	1	2	3	4	5	6	7	8
LHHH	CG RAM (8)		#	7	8	9	0	1	2	3	4	5	6	7	8	9
HLLL	CG RAM (1)		^	8	9	0	1	2	3	4	5	6	7	8	9	0
HLLH	CG RAM (2)		~	9	0	1	2	3	4	5	6	7	8	9	0	1
HLHL	CG RAM (3)		~	0	1	2	3	4	5	6	7	8	9	0	1	2
HLHH	CG RAM (4)		+	1	2	3	4	5	6	7	8	9	0	1	2	3
HHLL	CG RAM (5)		.	2	3	4	5	6	7	8	9	0	1	2	3	4
HHLH	CG RAM (6)		-	3	4	5	6	7	8	9	0	1	2	3	4	5
HHHL	CG RAM (7)		.	4	5	6	7	8	9	0	1	2	3	4	5	6
HHHH	CG RAM (8)		/	5	6	7	8	9	0	1	2	3	4	5	6	7

11. Instruction Table

Instruction	Instruction Code										Description	Execution time (fosc=270Khz)
	RS	R/W	DB7	DB6	DB5	DB4	DB3	DB2	DB1	DB0		
Clear Display	0	0	0	0	0	0	0	0	0	1	Write "00H" to DDRAM and set DDRAM address to "00H" from AC	1.53ms
Return Home	0	0	0	0	0	0	0	0	1	-	Set DDRAM address to "00H" from AC and return cursor to its original position if shifted. The contents of DDRAM are not changed.	1.53ms
Entry Mode Set	0	0	0	0	0	0	0	1	I/D	SH	Assign cursor moving direction and enable the shift of entire display.	39μ s
Display ON/OFF Control	0	0	0	0	0	0	1	D	C	B	Set display (D), cursor (C), and blinking of cursor (B) on/off control bit.	39μ s
Cursor or Display Shift	0	0	0	0	0	1	S/C	R/L	-	-	Set cursor moving and display shift control bit, and the direction, without changing of DDRAM data.	39μ s
Function Set	0	0	0	0	1	DL	N	F	-	-	Set interface data length (DL:8-bit/4-bit), numbers of display line (N:2-line/1-line)and, display font type (F:5×11 dots/5×8 dots)	39μ s
Set CGRAM Address	0	0	0	1	AC5	AC4	AC3	AC2	AC1	AC0	Set CGRAM address in address counter.	39μ s
Set DDRAM Address	0	0	1	AC6	AC5	AC4	AC3	AC2	AC1	AC0	Set DDRAM address in address counter.	39μ s
Read Busy Flag and Address	0	1	BF	AC6	AC5	AC4	AC3	AC2	AC1	AC0	Whether during internal operation or not can be known by reading BF. The contents of address counter can also be read.	0μ s
Write Data to RAM	1	0	D7	D6	D5	D4	D3	D2	D1	D0	Write data into internal RAM (DDRAM/CGRAM).	43μ s
Read Data from RAM	1	1	D7	D6	D5	D4	D3	D2	D1	D0	Read data from internal RAM (DDRAM/CGRAM).	43μ s

* " - " : don't care

12. Timing Characteristics

12.1 Write Operation

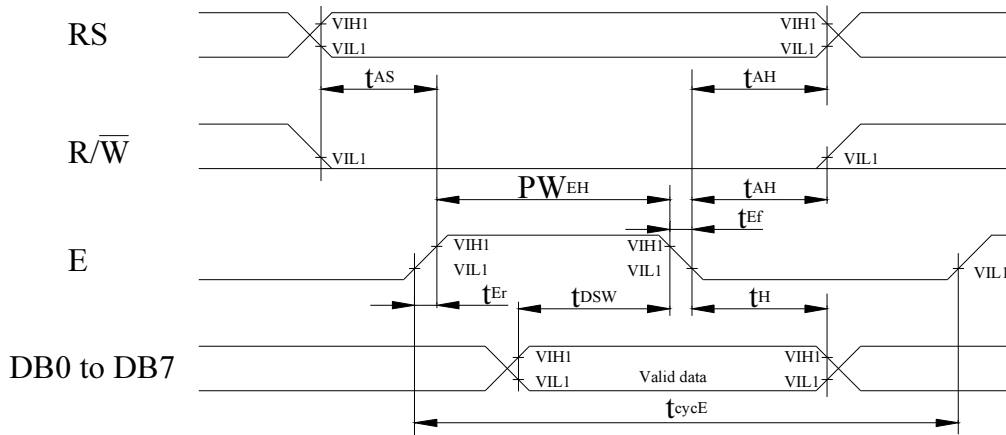

$T_a=25^{\circ}\text{C}$, $V_{DD}=5.0\pm 0.5\text{V}$

Item	Symbol	Min	Typ	Max	Unit
Enable cycle time	t_{cycE}	1200	—	—	ns
Enable pulse width (high level)	PW_{EH}	140	—	—	ns
Enable rise/fall time	t_{Er}, t_{Ef}	—	—	25	ns
Address set-up time (RS, R/W to E)	t_{AS}	0	—	—	ns
Address hold time	t_{AH}	10	—	—	ns
Data set-up time	t_{DSW}	40	—	—	ns
Data hold time	t_H	10	—	—	ns

12.2 Read Operation

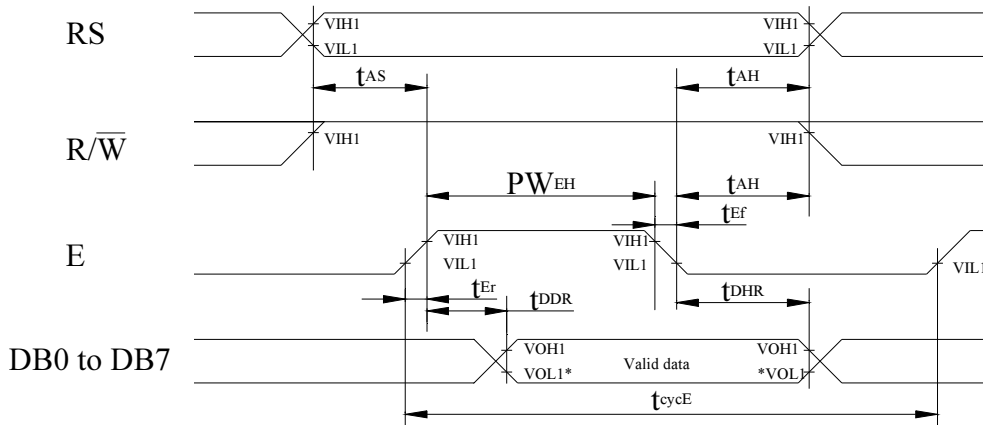

NOTE: *VOL1 is assumed to be 0.8V at 2 MHz operation.

T_a=25°C, VDD=5.0± 0.5V

Item	Symbol	Min	Typ	Max	Unit
Enable cycle time	t_{cycE}	1200	—	—	ns
Enable pulse width (high level)	PW_{EH}	140	—	—	ns
Enable rise/fall time	t_{Er}, t_{Ef}	—	—	25	ns
Address set-up time (RS, R/W to E)	t_{AS}	0	—	—	ns
Address hold time	t_{AH}	10	—	—	ns
Data delay time	t_{DDR}	—	—	100	ns
Data hold time	t_{DHR}	10	—	—	ns

13.Initializing of LCM

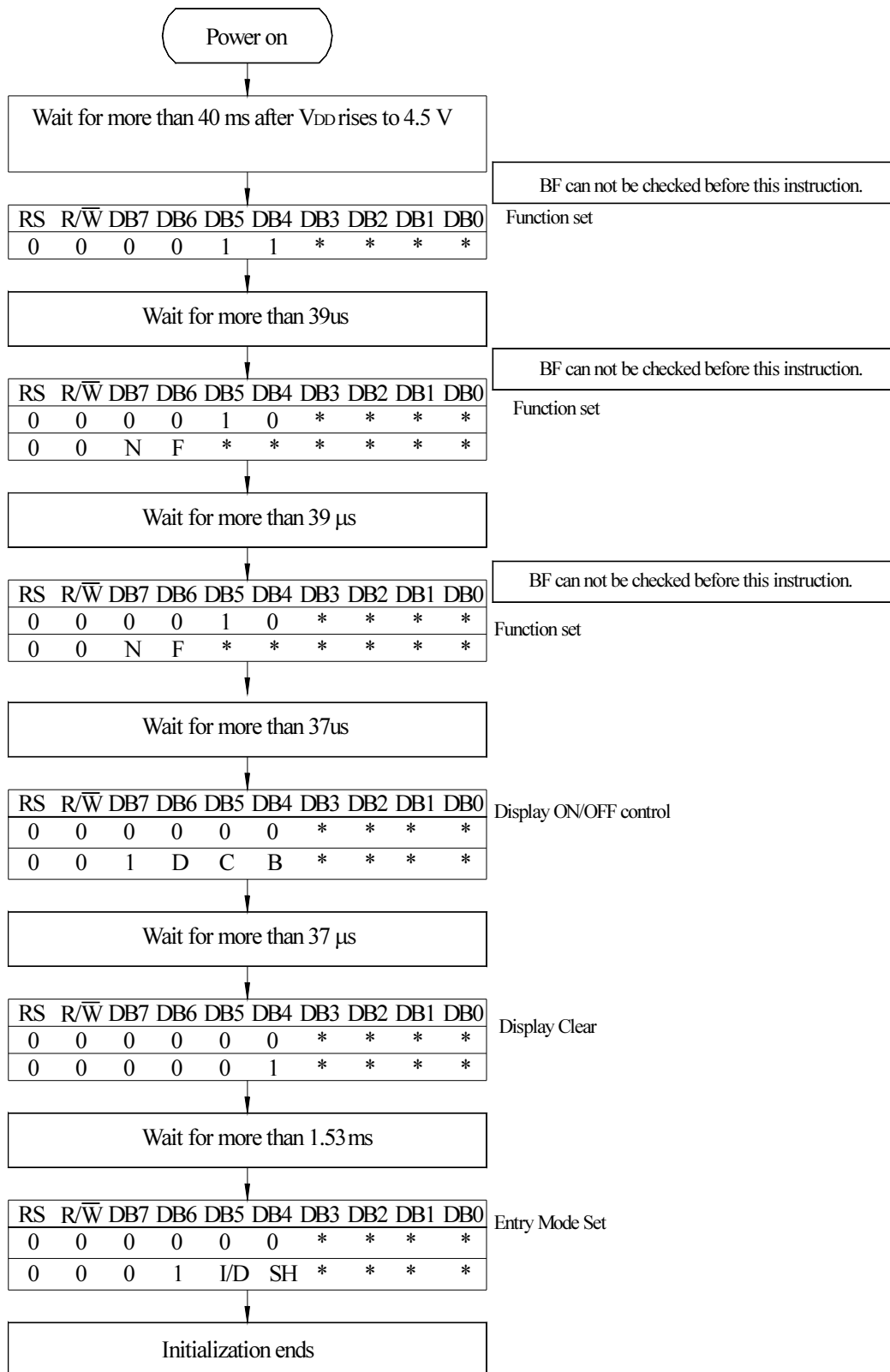

4-Bit Inerface

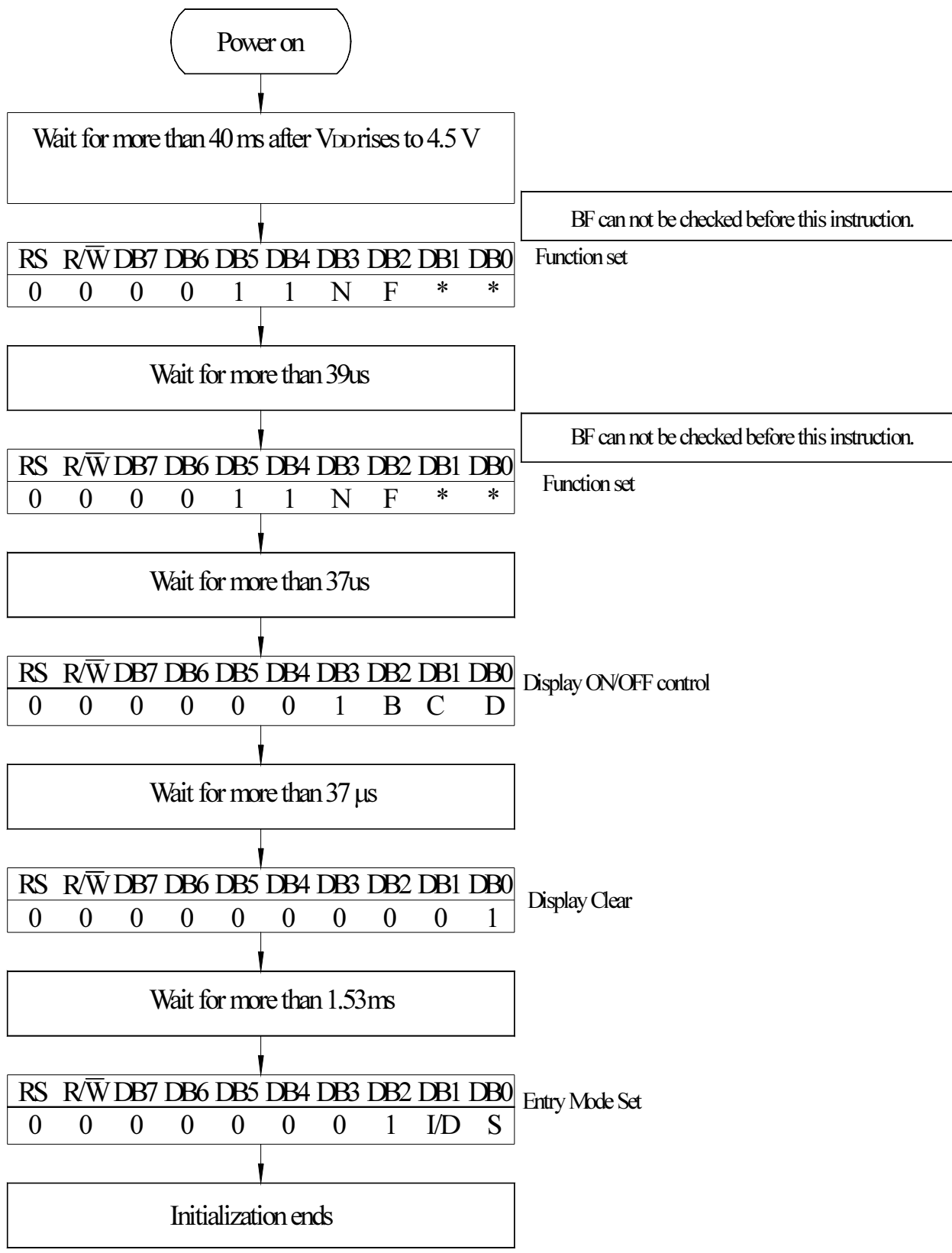

8-Bit Ineterface

14. Quality Assurance

Screen Cosmetic Criteria

Item	Defect	Judgment Criterion	Partition																				
1	Spots	<p>A)Clear</p> <table border="1"> <thead> <tr> <th>Size: d mm</th> <th>Acceptable Qty in active area</th> </tr> </thead> <tbody> <tr> <td>$d \leq 0.1$</td> <td>Disregard</td> </tr> <tr> <td>$0.1 < d \leq 0.2$</td> <td>6</td> </tr> <tr> <td>$0.2 < d \leq 0.3$</td> <td>2</td> </tr> <tr> <td>$0.3 < d$</td> <td>0</td> </tr> </tbody> </table> <p>Note: Including pin holes and defective dots which must be within one pixel size.</p> <p>B)Unclear</p> <table border="1"> <thead> <tr> <th>Size: d mm</th> <th>Acceptable Qty in active area</th> </tr> </thead> <tbody> <tr> <td>$d \leq 0.2$</td> <td>Disregard</td> </tr> <tr> <td>$0.2 < d \leq 0.5$</td> <td>6</td> </tr> <tr> <td>$0.5 < d \leq 0.7$</td> <td>2</td> </tr> <tr> <td>$0.7 < d$</td> <td>0</td> </tr> </tbody> </table>	Size: d mm	Acceptable Qty in active area	$d \leq 0.1$	Disregard	$0.1 < d \leq 0.2$	6	$0.2 < d \leq 0.3$	2	$0.3 < d$	0	Size: d mm	Acceptable Qty in active area	$d \leq 0.2$	Disregard	$0.2 < d \leq 0.5$	6	$0.5 < d \leq 0.7$	2	$0.7 < d$	0	Minor
Size: d mm	Acceptable Qty in active area																						
$d \leq 0.1$	Disregard																						
$0.1 < d \leq 0.2$	6																						
$0.2 < d \leq 0.3$	2																						
$0.3 < d$	0																						
Size: d mm	Acceptable Qty in active area																						
$d \leq 0.2$	Disregard																						
$0.2 < d \leq 0.5$	6																						
$0.5 < d \leq 0.7$	2																						
$0.7 < d$	0																						
2	Bubbles in Polarizer	<table border="1"> <thead> <tr> <th>Size: d mm</th> <th>Acceptable Qty in active area</th> </tr> </thead> <tbody> <tr> <td>$d \leq 0.3$</td> <td>Disregard</td> </tr> <tr> <td>$0.3 < d \leq 1.0$</td> <td>3</td> </tr> <tr> <td>$1.0 < d \leq 1.5$</td> <td>1</td> </tr> <tr> <td>$1.5 < d$</td> <td>0</td> </tr> </tbody> </table>	Size: d mm	Acceptable Qty in active area	$d \leq 0.3$	Disregard	$0.3 < d \leq 1.0$	3	$1.0 < d \leq 1.5$	1	$1.5 < d$	0	Minor										
Size: d mm	Acceptable Qty in active area																						
$d \leq 0.3$	Disregard																						
$0.3 < d \leq 1.0$	3																						
$1.0 < d \leq 1.5$	1																						
$1.5 < d$	0																						
3	Scratch	In accordance with spots cosmetic criteria. When the light reflects on the panel surface, the scratches are not to be remarkable.	Minor																				
4	Allowable Density	Above defects should be separated more than 30mm each other.	Minor																				
5	Coloration	Not to be noticeable coloration in the viewing area of the LCD panels. Back-light type should be judged with back-light on state only.	Minor																				

15. Reliability

Content of Reliability Test

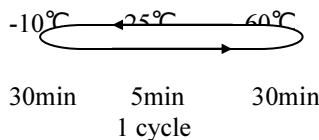
Environmental Test			
Test Item	Content of Test	Test Condition	Applicable Standard
High Temperature storage	Endurance test applying the high storage temperature for a long time.	60°C 200hrs	—
Low Temperature storage	Endurance test applying the high storage temperature for a long time.	-10°C 200hrs	—
High Temperature Operation	Endurance test applying the electric stress (Voltage & Current) and the thermal stress to the element for a long time.	50°C 200hrs	—
Low Temperature Operation	Endurance test applying the electric stress under low temperature for a long time.	0°C 200hrs	—
High Temperature/ Humidity Storage	Endurance test applying the high temperature and high humidity storage for a long time.	60°C, 90%RH 96hrs	—
High Temperature/ Humidity Operation	Endurance test applying the electric stress (Voltage & Current) and temperature / humidity stress to the element for a long time.	50°C, 90%RH 96hrs	—
Temperature Cycle	Endurance test applying the low and high temperature cycle.  30min 5min 30min 1 cycle	-10°C/60°C 10 cycles	—
Mechanical Test			
Vibration test	Endurance test applying the vibration during transportation and using.	10~22Hz→1.5mmp-p 22~500Hz→1.5G Total 0.5hrs	—
Shock test	Constructional and mechanical endurance test applying the shock during transportation.	50G Half sign wave 11 msdc 3 times of each direction	—
Atmospheric pressure test	Endurance test applying the atmospheric pressure during transportation by air.	115mbar 40hrs	—
Others			
Static electricity test	Endurance test applying the electric stress to the terminal.	VS=800V, RS=1.5kΩ CS=100pF 1 time	—

***Supply voltage for logic system=5V. Supply voltage for LCD system =Operating voltage at 25°C

16.Backlight Information

Specification

PARAMETER	SYMBOL	MIN	TYP	MAX	UNIT	TEST CONDITION
Supply Current	I _{LED}	—	130	—	mA	V=4.2V
Supply Voltage	V	—	4.2	4.6	V	—
Reverse Voltage	V _R	—	—	8	V	—
Luminous Intensity	I _V	60	—	—	CD/M ²	I _{LED} =130mA
Wave Length	λ _p	—	571	—	nm	I _{LED} =130mA
Life Time	—	—	100000	—	Hr.	V ≤ 4.6V
Color	Yellow Green					