

Power MOSFET

PRODUCT SUMMARY		
V_{DS} (V)	- 200	
$R_{DS(on)}$ (Ω)	$V_{GS} = - 10$ V	1.5
Q_g (Max.) (nC)	22	
Q_{gs} (nC)	12	
Q_{gd} (nC)	10	
Configuration	Single	

FEATURES

- Dynamic dV/dt Rating
- P-Channel
- Fast Switching
- Ease of Paralleling
- Simple Drive Requirements
- Lead (Pb)-free Available

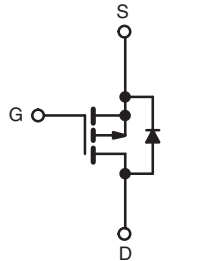
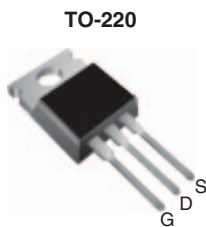

Available

RoHS*
 COMPLIANT

P-Channel MOSFET

DESCRIPTION

Third generation Power MOSFETs from Vishay provide the designer with the best combination of fast switching, ruggedized device design, low on-resistance and cost-effectiveness.

The TO-220 package is universally preferred for all commercial-industrial applications at power dissipation levels to approximately 50 W. The low thermal resistance and low package cost of the TO-220 contribute to its wide acceptance throughout the industry.

ORDERING INFORMATION	
Package	TO-220
Lead (Pb)-free	IRF9620PbF
	SiHF9620-E3
SnPb	IRF9620
	SiHF9620

ABSOLUTE MAXIMUM RATINGS $T_C = 25$ °C, unless otherwise noted					
PARAMETER			SYMBOL	LIMIT	UNIT
Drain-Source Voltage			V_{DS}	- 200	V
Gate-Source Voltage			V_{GS}	± 20	
Continuous Drain Current	V_{GS} at - 10 V	$T_C = 25$ °C	I_D	- 3.5	A
		$T_C = 100$ °C		- 2.0	
Pulsed Drain Current ^a			I_{DM}	- 14	
Linear Derating Factor				0.32	W/°C
Maximum Power Dissipation	$T_C = 25$ °C		P_D	40	W
Peak Diode Recovery dV/dt^b			dV/dt	- 5.0	V/ns
Operating Junction and Storage Temperature Range			T_J, T_{stg}	- 55 to + 150	°C
Soldering Recommendations (Peak Temperature)	for 10 s			300°	
Mounting Torque	6-32 or M3 screw			10	
				1.1	N · m



Notes

- Repetitive rating; pulse width limited by maximum junction temperature (see fig. 11).
- $I_{SD} \leq - 3.5$ A, $dI/dt \leq 95$ A/ μ s, $V_{DD} \leq V_{DS}$, $T_J \leq 150$ °C.
- 1.6 mm from case.

* Pb containing terminations are not RoHS compliant, exemptions may apply

THERMAL RESISTANCE RATINGS				
PARAMETER	SYMBOL	TYP.	MAX.	UNIT
Maximum Junction-to-Ambient	R_{thJA}	-	62	°C/W
Case-to-Sink, Flat, Greased Surface	R_{thCS}	0.50	-	
Maximum Junction-to-Case (Drain)	R_{thJC}	-	3.1	

SPECIFICATIONS $T_J = 25\text{ }^\circ\text{C}$, unless otherwise noted

PARAMETER	SYMBOL	TEST CONDITIONS	MIN.	TYP.	MAX.	UNIT
Static						
Drain-Source Breakdown Voltage	V_{DS}	$V_{GS} = 0\text{ V}, I_D = -250\text{ }\mu\text{A}$	-200	-	-	V
V_{DS} Temperature Coefficient	$\Delta V_{DS}/T_J$	Reference to $25\text{ }^\circ\text{C}$, $I_D = -1\text{ mA}$	-	-0.22	-	V/°C
Gate-Source Threshold Voltage	$V_{GS(th)}$	$V_{DS} = V_{GS}, I_D = -250\text{ }\mu\text{A}$	-2.0	-	-4.0	V
Gate-Source Leakage	I_{GSS}	$V_{GS} = \pm 20\text{ V}$	-	-	± 100	nA
Zero Gate Voltage Drain Current	I_{DSS}	$V_{DS} = -200\text{ V}, V_{GS} = 0\text{ V}$	-	-	-100	μA
		$V_{DS} = -160\text{ V}, V_{GS} = 0\text{ V}, T_J = 125\text{ }^\circ\text{C}$	-	-	-500	
Drain-Source On-State Resistance	$R_{DS(on)}$	$V_{GS} = -10\text{ V}, I_D = -1.5\text{ A}^b$	-	-	1.5	Ω
Forward Transconductance	g_{fs}	$V_{DS} = -50\text{ V}, I_D = -1.5\text{ A}^b$	1.0	-	-	S
Dynamic						
Input Capacitance	C_{iss}	$V_{GS} = 0\text{ V}, V_{DS} = -25\text{ V}, f = 1.0\text{ MHz}$, see fig. 5	-	350	-	pF
Output Capacitance	C_{oss}		-	100	-	
Reverse Transfer Capacitance	C_{rss}		-	30	-	
Total Gate Charge	Q_g	$V_{GS} = -10\text{ V}, I_D = -4.0\text{ A}, V_{DS} = -160\text{ V}$, see fig. 11 and 18 ^b	-	-	22	nC
Gate-Source Charge	Q_{gs}		-	-	12	
Gate-Drain Charge	Q_{gd}		-	-	10	
Turn-On Delay Time	$t_{d(on)}$	$V_{DD} = -100\text{ V}, I_D = -1.5\text{ A}, R_G = 50\text{ }\Omega, R_D = 67\text{ }\Omega$, see fig. 17 ^b	-	15	-	ns
Rise Time	t_r		-	25	-	
Turn-Off Delay Time	$t_{d(off)}$		-	20	-	
Fall Time	t_f		-	15	-	
Internal Drain Inductance	L_D	Between lead, 6 mm (0.25") from package and center of die contact 	-	4.5	-	nH
Internal Source Inductance	L_S		-	7.5	-	
Drain-Source Body Diode Characteristics						
Continuous Source-Drain Diode Current	I_S	MOSFET symbol showing the integral reverse p - n junction diode 	-	-	-3.5	A
Pulsed Diode Forward Current ^a	I_{SM}		-	-	-14	
Body Diode Voltage	V_{SD}	$T_J = 25\text{ }^\circ\text{C}, I_S = -3.5\text{ A}, V_{GS} = 0\text{ V}^b$	-	-	-7.0	V
Body Diode Reverse Recovery Time	t_{rr}	$T_J = 25\text{ }^\circ\text{C}, I_F = -3.5\text{ A}, dI/dt = 100\text{ A}/\mu\text{s}^b$	-	300	450	ns
Body Diode Reverse Recovery Charge	Q_{rr}		-	1.9	2.9	μC
Forward Turn-On Time	t_{on}	Intrinsic turn-on time is negligible (turn-on is dominated by L_S and L_D)				

Notes

- a. Repetitive rating; pulse width limited by maximum junction temperature (see fig. 11).
- b. Pulse width $\leq 300\text{ }\mu\text{s}$; duty cycle $\leq 2\%$.

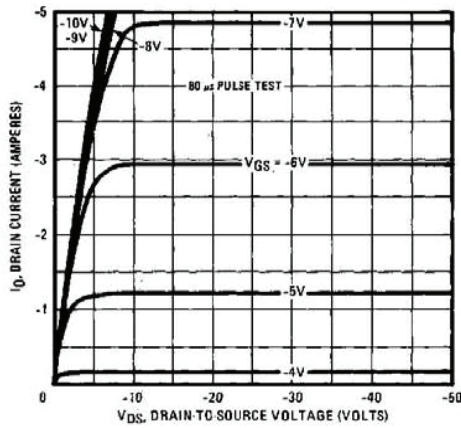
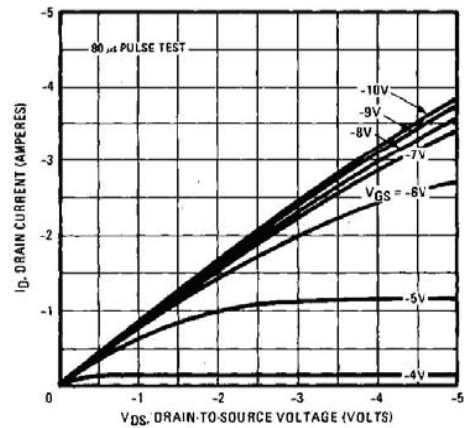
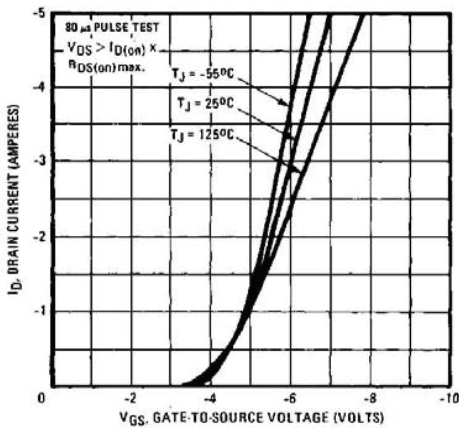
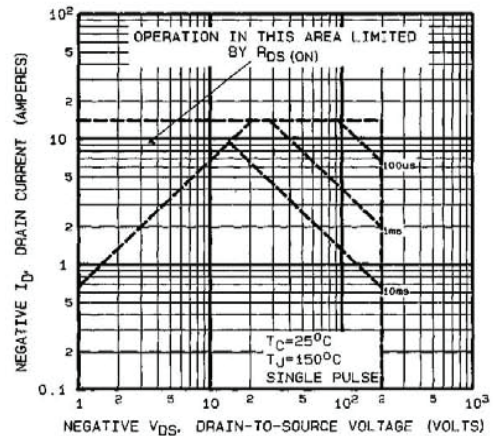
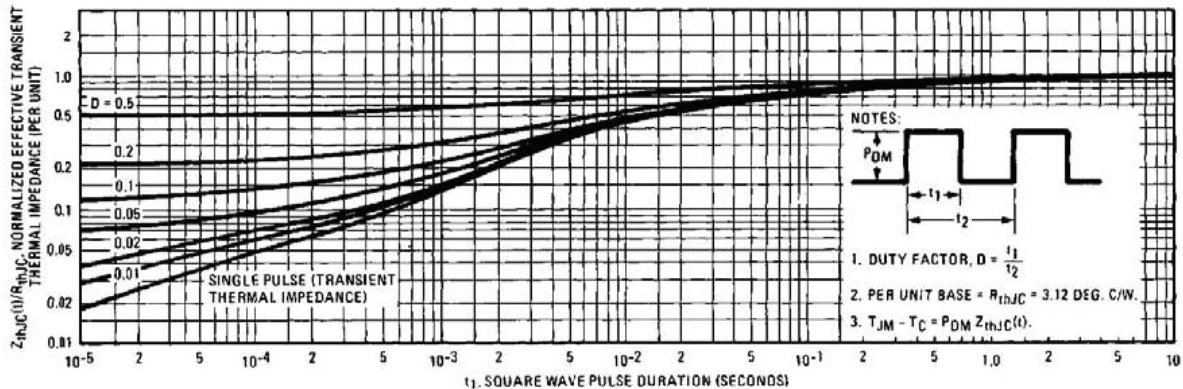
TYPICAL CHARACTERISTICS 25 °C, unless otherwise noted

Fig. 1 - Typical Output Characteristics

Fig. 3 - Typical Saturation Characteristics

Fig. 2 - Typical Transfer Characteristics

Fig. 4 - Maximum Safe Operating Area

Fig. 5 - Maximum Effective Transient Thermal Impedance, Junction-to-Case vs. Pulse Duration

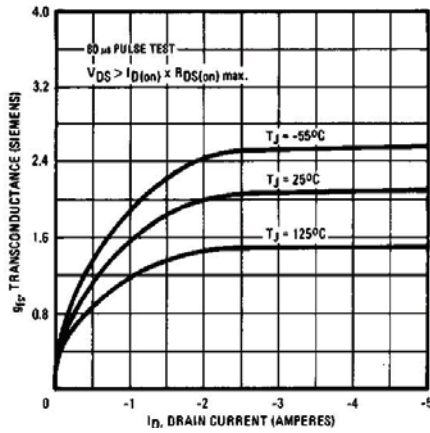

Fig. 6 - Typical Transconductance vs. Drain Current

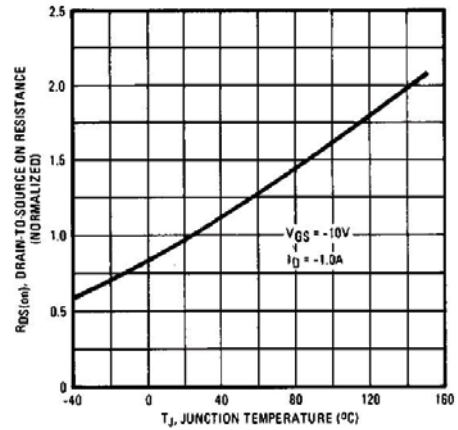

Fig. 9 - Normalized On-Resistance vs. Temperature

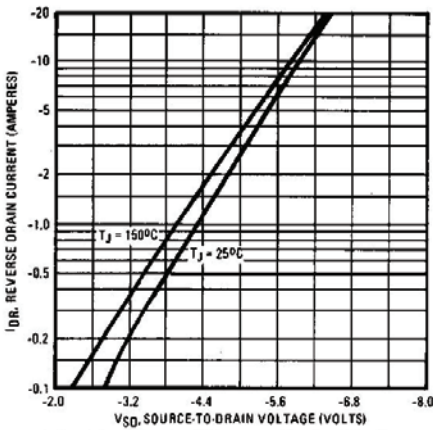

Fig. 7 - Typical Source-Drain Diode Forward Voltage

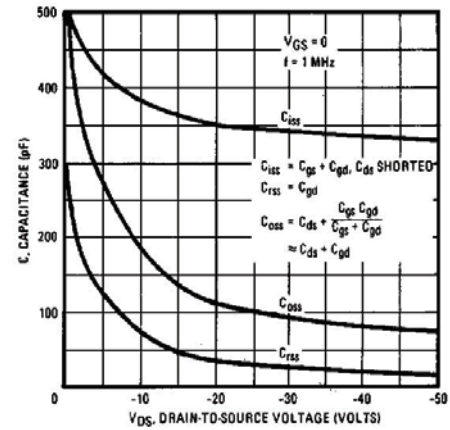

Fig. 10 - Typical Capacitance vs. Drain-to-Source Voltage

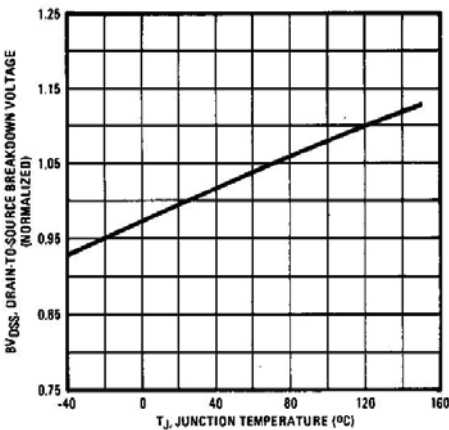

Fig. 8 - Breakdown Voltage vs. Temperature

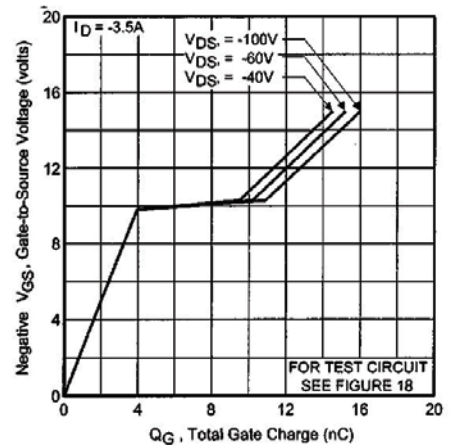

Fig. 11 - Typical Gate Charge vs. Gate-to-Source Voltage

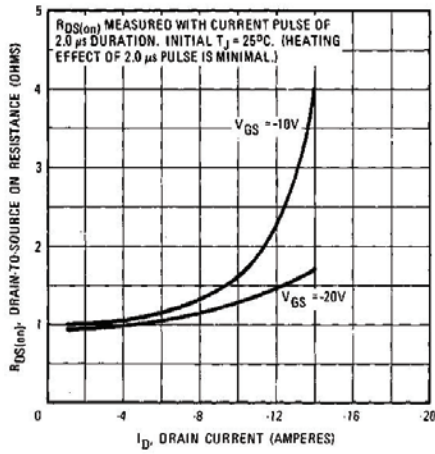

Fig. 12 - Typical On-Resistance vs. Drain Current

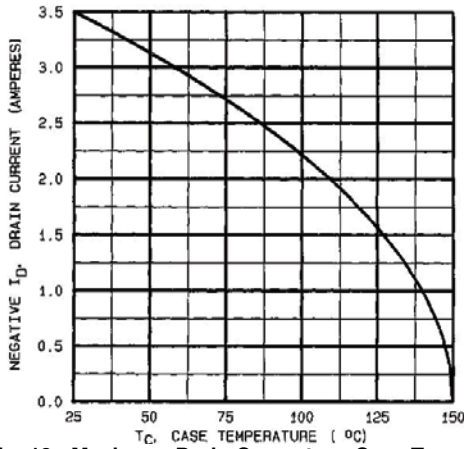

Fig. 13 - Maximum Drain Current vs. Case Temperature

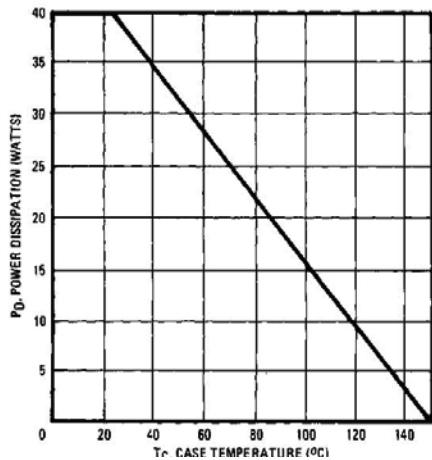

Fig. 14 - Power vs. Temperature Derating Curve

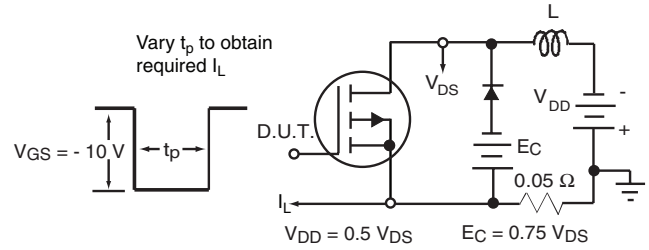

Fig. 15 - Clamped Inductive Test Circuit

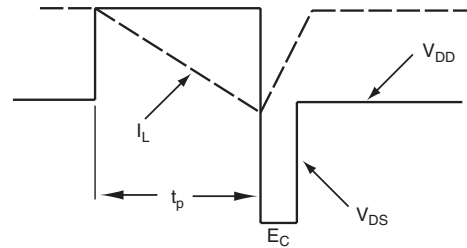

Fig. 16 - Clamped Inductive Waveforms

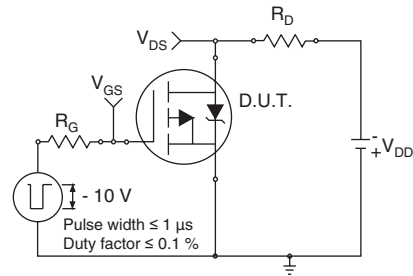

Fig. 17a - Switching Time Test Circuit

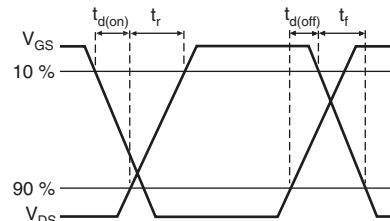

Fig. 17b - Switching Time Waveforms

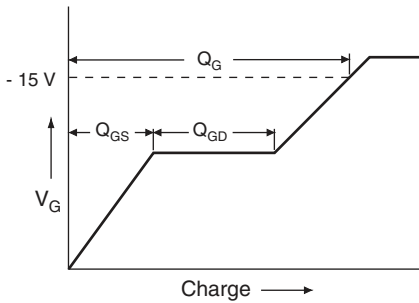

Fig. 18a - Basic Gate Charge Waveform

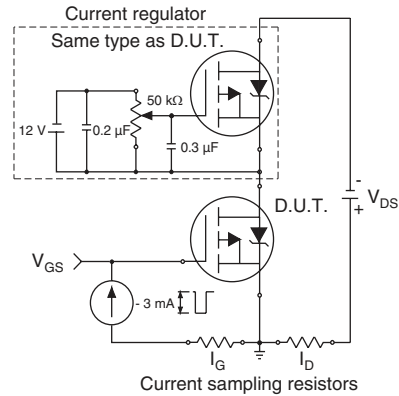
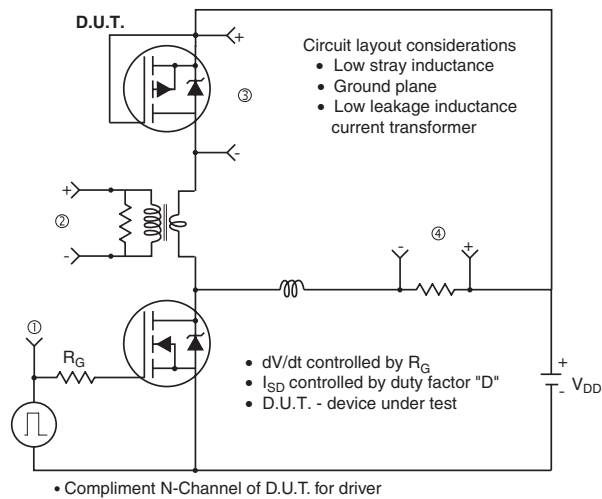
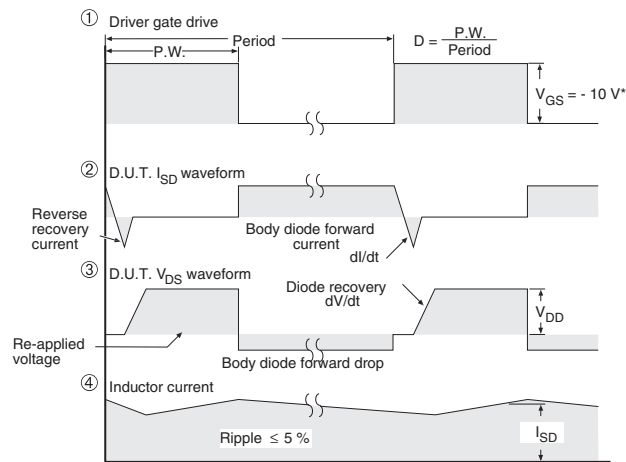

Fig. 18b - Gate Charge Test Circuit

Peak Diode Recovery dV/dt Test Circuit



• Compliment N-Channel of D.U.T. for driver



* $V_{GS} = -5\text{ V}$ for logic level and -3 V drive devices

Fig. 19 - For P-Channel

Vishay Siliconix maintains worldwide manufacturing capability. Products may be manufactured at one of several qualified locations. Reliability data for Silicon Technology and Package Reliability represent a composite of all qualified locations. For related documents such as package/tape drawings, part marking, and reliability data, see <http://www.vishay.com/ppg?91082>.



Disclaimer

All product specifications and data are subject to change without notice.

Vishay Intertechnology, Inc., its affiliates, agents, and employees, and all persons acting on its or their behalf (collectively, "Vishay"), disclaim any and all liability for any errors, inaccuracies or incompleteness contained herein or in any other disclosure relating to any product.

Vishay disclaims any and all liability arising out of the use or application of any product described herein or of any information provided herein to the maximum extent permitted by law. The product specifications do not expand or otherwise modify Vishay's terms and conditions of purchase, including but not limited to the warranty expressed therein, which apply to these products.

No license, express or implied, by estoppel or otherwise, to any intellectual property rights is granted by this document or by any conduct of Vishay.

The products shown herein are not designed for use in medical, life-saving, or life-sustaining applications unless otherwise expressly indicated. Customers using or selling Vishay products not expressly indicated for use in such applications do so entirely at their own risk and agree to fully indemnify Vishay for any damages arising or resulting from such use or sale. Please contact authorized Vishay personnel to obtain written terms and conditions regarding products designed for such applications.

Product names and markings noted herein may be trademarks of their respective owners.