

CGHV14800

800 W, 1200 - 1400 MHz, 50 V, GaN HEMT for L-Band Radar Systems

Cree's CGHV14800 is a gallium nitride (GaN) high electron mobility transistor (HEMT) designed specifically with high efficiency, high gain and wide bandwidth capabilities, which makes the CGHV14800 ideal for 1.2 - 1.4 GHz pulsed L-Band radar amplifier applications, such as air traffic control (ATC) radar, weather radar, penetration radars, antimissile system radars, target tracking radars and long range surveillance radars. The GaN HEMT typically operates at 50 V, typically delivering >65% drain efficiency. The package options are ceramic/metal flange package.

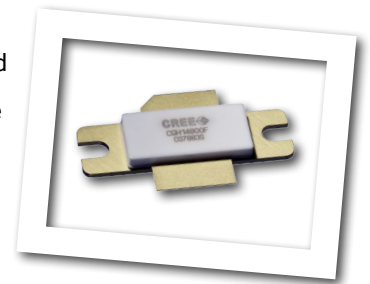

Package Type: 440117
PN: CGHV14800F

Typical Performance Over 1.2-1.4 GHz ($T_c = 25^\circ\text{C}$) of Demonstration Amplifier

Parameter	1.2 GHz	1.25 GHz	1.3 GHz	1.35 GHz	1.4 GHz	Units
Output Power	900	900	870	870	920	W
Power Gain	14.5	14.5	14.0	14.0	14.0	dB
Drain Efficiency	68	67	67	63	62	%

Note:

Measured in the CGHV14800-AMP amplifier circuit, under 3 μs pulse width, 3% duty cycle, $P_{IN} = 45 \text{ dBm}$.

Features

- Reference design amplifier 1.2 - 1.4 GHz Operation
- 800 W Minimum Output Power
- 14 dB Power Gain
- 69% Typical Drain Efficiency
- <0.3 dB Pulsed Amplitude Droop
- Internally input and output matched

Large Signal Models Available for ADS and MWO

Absolute Maximum Ratings (not simultaneous)

Parameter	Symbol	Rating	Units	Conditions
Drain-Source Voltage	V_{DSS}	125	Volts	25°C
Gate-to-Source Voltage	V_{GS}	-10, +2	Volts	25°C
Storage Temperature	T_{STG}	-65, +150	°C	
Operating Junction Temperature	T_J	225	°C	
Maximum Forward Gate Current	I_{GMAX}	132	mA	25°C
Maximum DC Current ¹	I_{DCMAX}	24	A	25°C
Soldering Temperature ²	T_S	245	°C	
Screw Torque	τ	40	in-oz	
CW Thermal Resistance, Junction to Case ³	$R_{\theta JC}$	0.44	°C/W	$P_{DISS} = 398 \text{ W}, 50^\circ\text{C}$
Pulsed Thermal Resistance, Junction to Case ³	$R_{\theta JC}$	0.10	°C/W	$P_{DISS} = 664 \text{ W}, 3 \mu\text{sec}, 3\%, 85^\circ\text{C}$
Case Operating Temperature ⁴	T_C	-40, +100	°C	$P_{DISS} = 664 \text{ W}, 100 \mu\text{sec}, 10\%$

Note:

¹ Current limit for long term, reliable operation

² Refer to the Application Note on soldering at <http://www.cree.com/rf/document-library>

³ Measured for the CGHV14800F

⁴ See also, the Power Dissipation De-rating Curve on Page x

Electrical Characteristics

Characteristics	Symbol	Min.	Typ.	Max.	Units	Conditions
DC Characteristics¹ ($T_C = 25^\circ\text{C}$)						
Gate Threshold Voltage	$V_{GS(th)}$	-3.8	-3.0	-2.3	V_{DC}	$V_{DS} = 10 \text{ V}, I_D = 83.6 \text{ mA}$
Gate Quiescent Voltage	$V_{GS(Q)}$	-	-2.7	-	V_{DC}	$V_{DS} = 50 \text{ V}, I_D = 500 \text{ mA}$
Saturated Drain Current ²	I_{DS}	80.3	123.5	-	A	$V_{DS} = 6.0 \text{ V}, V_{GS} = 2.0 \text{ V}$
Drain-Source Breakdown Voltage	V_{BR}	150	-	-	V_{DC}	$V_{GS} = -8 \text{ V}, I_D = 83.6 \text{ mA}$
RF Characteristics³ ($T_C = 25^\circ\text{C}, F_0 = 1.3 \text{ GHz}$ unless otherwise noted)						
Output Power	P_{OUT}	-	900	-	W	$V_{DD} = 50 \text{ V}, I_{DQ} = 800 \text{ mA}, P_{IN} = 45 \text{ dBm}$
Drain Efficiency	D_E	-	68	-	%	$V_{DD} = 50 \text{ V}, I_{DQ} = 800 \text{ mA}, P_{IN} = 45 \text{ dBm}$
Power Gain	G_P	-	14.5	-	dB	$V_{DD} = 50 \text{ V}, I_{DQ} = 800 \text{ mA}, P_{IN} = 45 \text{ dBm}$
Pulsed Amplitude Droop	D	-	-0.3	-	dB	$V_{DD} = 50 \text{ V}, I_{DQ} = 800 \text{ mA}$
Output Mismatch Stress	VSWR	-	5 : 1	-	Ψ	No damage at all phase angles, $V_{DD} = 50 \text{ V}, I_{DQ} = 800 \text{ mA}, P_{IN} = 45 \text{ dBm}$ Pulsed
Dynamic Characteristics						
Input Capacitance	C_{GS}	-	326	-	pF	$V_{DS} = 50 \text{ V}, V_{GS} = -8 \text{ V}, f = 1 \text{ MHz}$
Output Capacitance	C_{DS}	-	643	-	pF	$V_{DS} = 50 \text{ V}, V_{GS} = -8 \text{ V}, f = 1 \text{ MHz}$
Feedback Capacitance	C_{GD}	-	3.9	-	pF	$V_{DS} = 50 \text{ V}, V_{GS} = -8 \text{ V}, f = 1 \text{ MHz}$

Notes:

¹ Measured on wafer prior to packaging.

² Scaled from PCM data.

³ Measured in CGHV14800-AMP. Pulse Width = 3 μs , Duty Cycle = 3%.

Typical Pulsed Performance

Figure 1. - Saturated Output Power and Drain Efficiency vs Frequency of the CGHV14800F in the CGHV14800F-AMP

$V_{DD} = 50\text{ V}$, $I_{DQ} = 800\text{ mA}$, Pulse Width = $3\ \mu\text{S}$, Duty Cycle = 3%

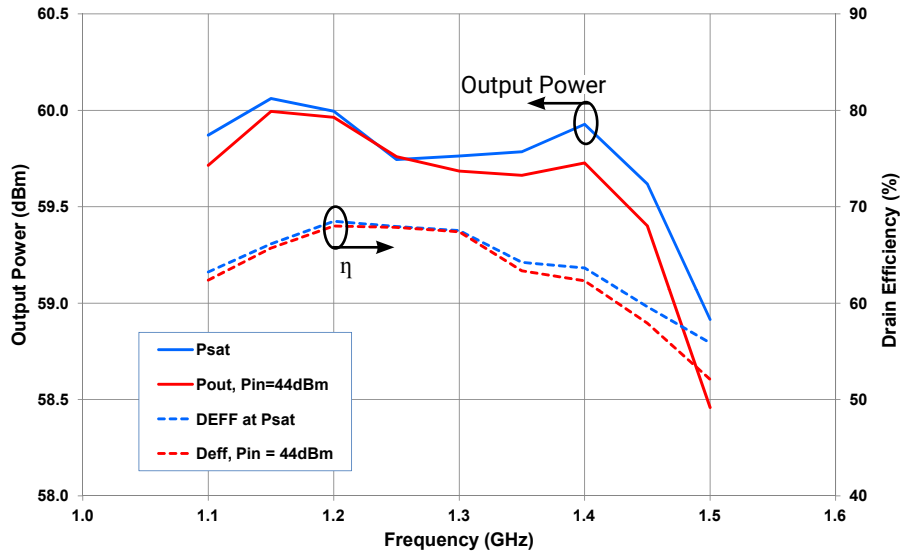
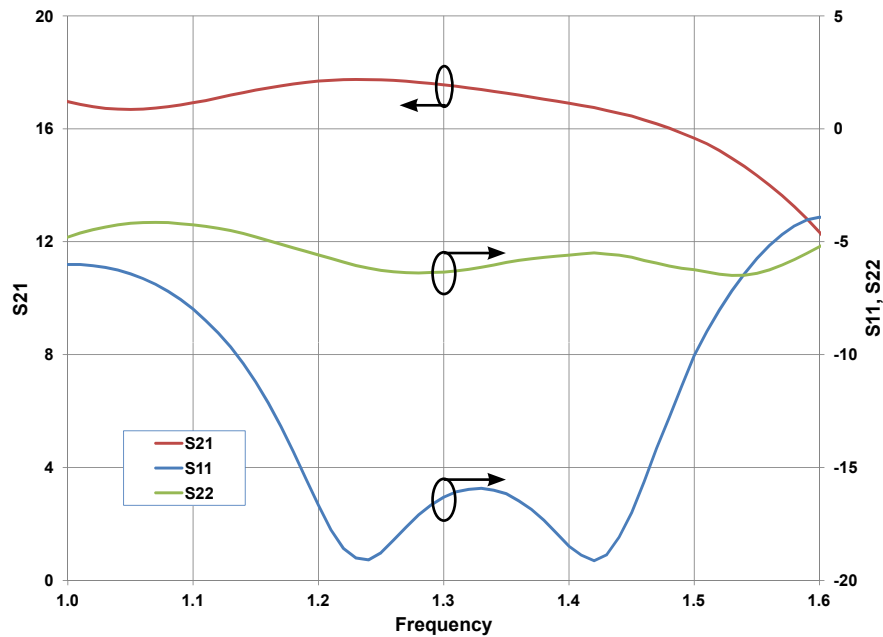

Figure 2. - Small Signal Gain and Return Losses vs Frequency of the CGHV14800F in the CGHV14800F-AMP

$V_{DD} = 50\text{ V}$, $I_{DQ} = 800\text{ mA}$, Pulse Width = $100\ \mu\text{S}$, Duty Cycle = 5%



CGHV14800F-AMP Demonstration Amplifier Circuit Bill of Materials

Designator	Description	Qty
R1	RES, 5.1,OHM, +/- 1%, 0.25W, 1206	1
R2	RES,1/16W,0603,1%,4.99K OHMS	1
R3	RES 5360HM +/- 1%, 0.25W,1206	1
L1	INDUCTOR,CHIP,6.8nH,0603 SMT	1
C1, C14, C15	CAP, 100 PF +/- 5%,, 250V, 0805, ATC 600F	3
C16	CAP, 2.0pF, +/-0.1pF, 0603, ATC	1
C2	CAP, 33pF, +/-5%, 0603, ATC	1
C3, C8	CAP, 470PF, 5%, 100V, 0603, X7R	2
C4, C9	CAP,33000PF, 0805,100V, X7R	2
C5, C10	CAP, 1.0UF, 100V, 10%, X7R, 1210	2
C6	CAP 10UF 16V TANTALUM	1
C7	CAP, 33 PF +/- 5%,, 250V, 0805, ATC 600F	1
C11	CAP, 3300 UF, +/-20%, 100V, ELECTROLYTIC	1
C14	CAP 10uF 16V TANTALUM	1
J1,J2	CONN, SMA, PANEL MOUNT JACK, FLANGE, 4-HOLE, BLUNT POST	2
J3	HEADER RT>PLZ .1CEN LK 9POS	1
J4	CONNECTOR ; SMB, Straight, JACK,SMD	1
W1	CABLE ,18 AWG, 4.2	1
	PCB, TMM10i, 0.025" THK, CGHV14800 1.2-1.4GHZ	1
	2-56 SOC HD SCREW 1/4 SS	4
	#2 SPLIT LOCKWASHER SS	4
Q1	CGHV14800F	1

CGHV14800F-AMP Demonstration Amplifier Circuit

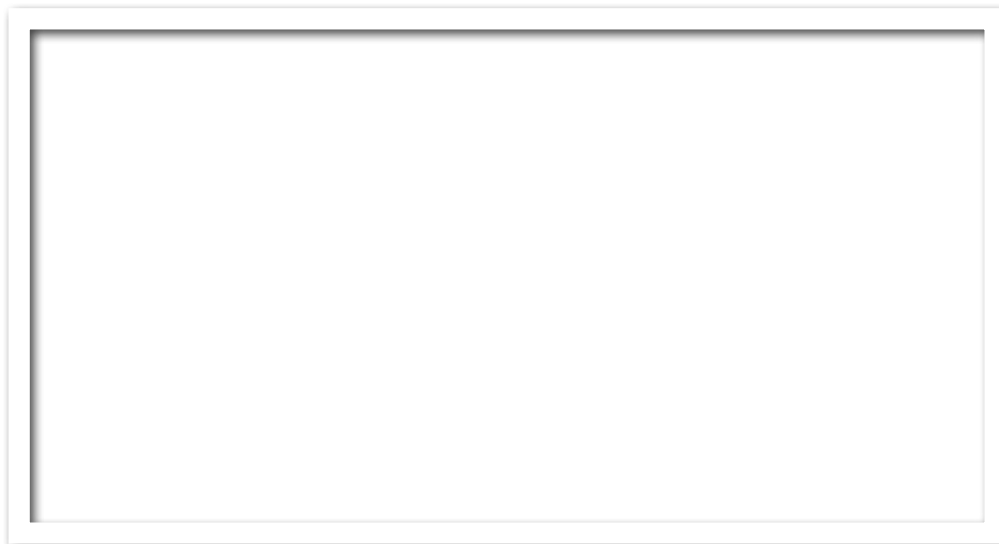

CGHV14800-AMP Demonstration Amplifier Circuit Outline

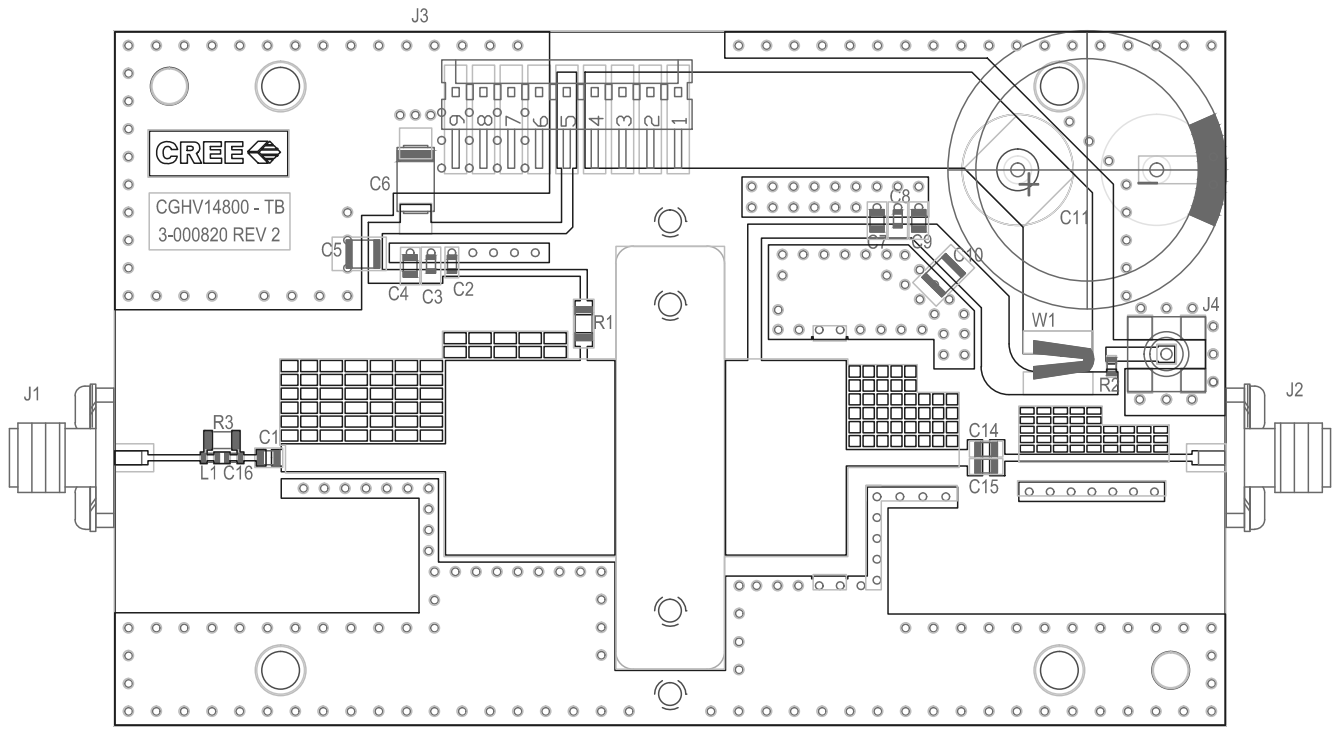

CGHV14800-AMP Demonstration Amplifier Circuit Schematic

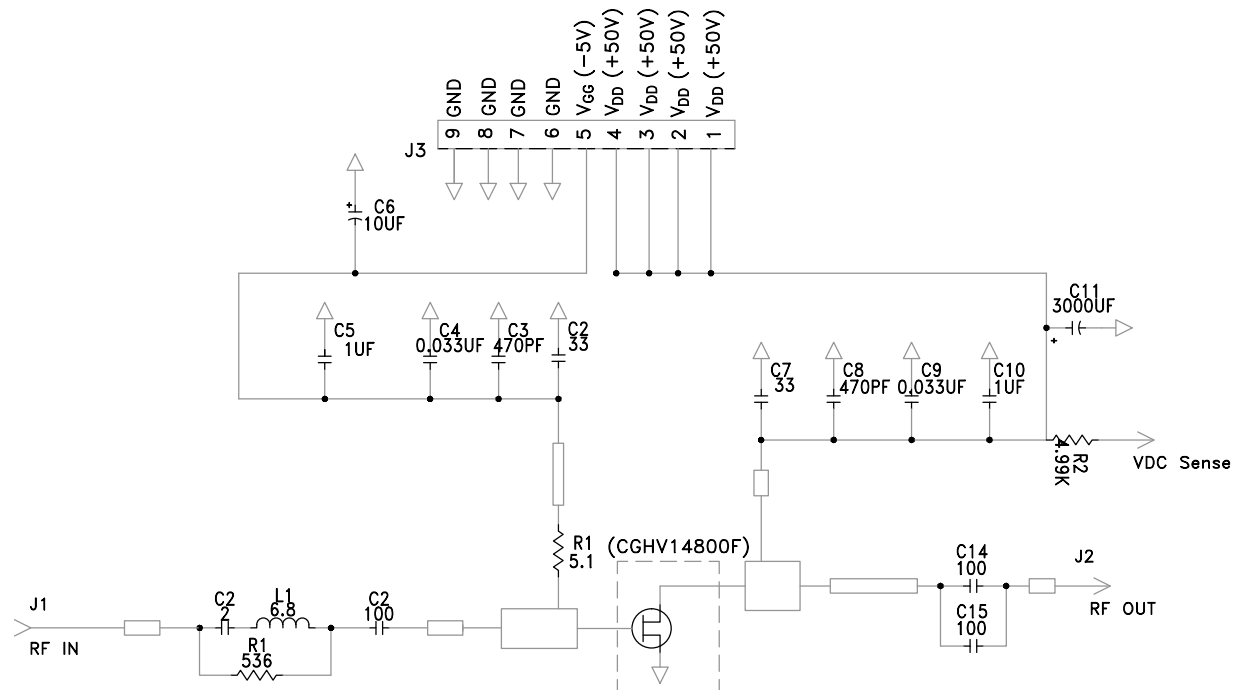

Product Dimensions CGHV14800F (Package Type – 440117)

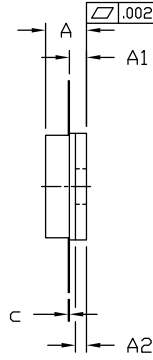
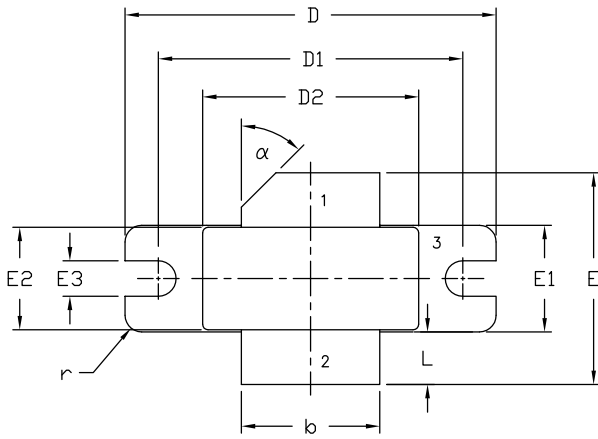

PIN 1. GATE
2. DRAIN
3. SOURCE

NOTES:

1. DIMENSIONING AND TOLERANCING PER ANSI Y14.5M - 1994.
2. CONTROLLING DIMENSION: INCH.
3. ADHESIVE FROM LID MAY EXTEND A MAXIMUM OF 0.020" BEYOND EDGE OF LID.
4. LID MAY BE MISALIGNED TO THE BODY OF PACKAGE BY A MAXIMUM OF 0.008" IN ANY DIRECTION.

DIM	INCHES		MILLIMETERS		NOTES
	MIN	MAX	MIN	MAX	
A	0.138	0.158	3.51	4.01	
A1	0.057	0.067	1.45	1.70	
A2	0.035	0.045	0.89	1.14	
b	0.495	0.505	12.57	12.83	2x
c	0.003	0.006	0.08	0.15	
D	1.335	1.345	33.91	34.16	
D1	1.095	1.105	27.81	28.07	
D2	0.773	0.787	19.63	20.00	
E	0.745	0.785	18.92	19.94	
E1	0.380	0.390	9.65	9.91	
E2	0.365	0.375	9.72	9.53	
E3	0.123	0.133	3.12	3.38	
L	0.170	0.210	4.32	5.33	2x
r	0.06	TYP	0.06	TYP	4x
α	45°	REF	45°	REF	

CGHV14800F

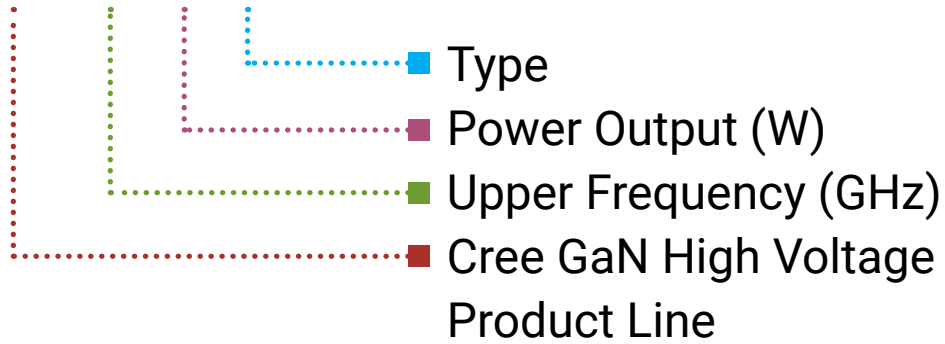

Parameter	Value	Units
Upper Frequency ¹	1.4	GHz
Power Output	800	W
Type	F = Flanged P = Package	-

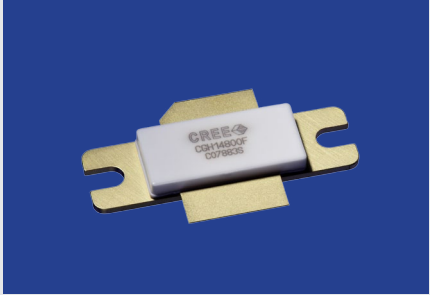

Table 1.

Note¹: Alpha characters used in frequency code indicate a value greater than 9.9 GHz. See Table 2 for value.

Character Code	Code Value
A	0
B	1
C	2
D	3
E	4
F	5
G	6
H	7
J	8
K	9
Examples:	1A = 10.0 GHz 2H = 27.0 GHz

Table 2.

Product Ordering Information

Order Number	Description	Unit of Measure	Image
CGHV14800F	GaN HEMT	Each	
CGHV14800-TB	Test board without GaN HEMT	Each	
CGHV14800F-AMP	Test board with GaN HEMT installed	Each	



Disclaimer

Specifications are subject to change without notice. Cree, Inc. believes the information contained within this data sheet to be accurate and reliable. However, no responsibility is assumed by Cree for any infringement of patents or other rights of third parties which may result from its use. No license is granted by implication or otherwise under any patent or patent rights of Cree. Cree makes no warranty, representation or guarantee regarding the suitability of its products for any particular purpose. "Typical" parameters are the average values expected by Cree in large quantities and are provided for information purposes only. These values can and do vary in different applications and actual performance can vary over time. All operating parameters should be validated by customer's technical experts for each application. Cree products are not designed, intended or authorized for use as components in applications intended for surgical implant into the body or to support or sustain life, in applications in which the failure of the Cree product could result in personal injury or death or in applications for planning, construction, maintenance or direct operation of a nuclear facility.

For more information, please contact:

Cree, Inc.
4600 Silicon Drive
Durham, North Carolina, USA 27703
www.cree.com/rf

Sarah Miller
Marketing
Cree, RF Components
1.919.407.5302

Ryan Baker
Marketing & Sales
Cree, RF Components
1.919.407.7816

Tom Dekker
Sales Director
Cree, RF Components
1.919.407.5639