

## LM2940x 1-A Low Dropout Regulator

### 1 Features

- Input Voltage Range = 6 V to 26 V
- Dropout Voltage Typically 0.5 V at  $I_{OUT} = 1$  A
- Output Current in Excess of 1 A
- Output Voltage Trimmed Before Assembly
- Reverse Battery Protection
- Internal Short Circuit Current Limit
- Mirror Image Insertion Protection
- P<sup>+</sup> Product Enhancement Tested

### 2 Applications

- Post Regulator for Switching Supplies
- Logic Power Supplies
- Industrial Instrumentation

### 3 Description

The LM2940-N and LM2940C positive voltage regulators feature the ability to source 1 A of output current with a dropout voltage of typically 0.5 V and a maximum of 1 V over the entire temperature range. Furthermore, a quiescent current reduction circuit has been included which reduces the ground current when the differential between the input voltage and the output voltage exceeds approximately 3 V. The quiescent current with 1 A of output current and an input-output differential of 5 V is therefore only 30 mA. Higher quiescent currents only exist when the regulator is in the dropout mode ( $V_{IN} - V_{OUT} \leq 3$  V).

Designed also for vehicular applications, the LM2940-N and LM2940C and all regulated circuitry are protected from reverse battery installations or 2-battery jumps. During line transients, such as load dump when the input voltage can momentarily exceed the specified maximum operating voltage, the regulator will automatically shut down to protect both the internal circuits and the load. The LM2940-N and LM2940C cannot be harmed by temporary mirror-image insertion. Familiar regulator features such as short circuit and thermal overload protection are also provided.

#### Device Information<sup>(1)</sup>

PART NUMBER	PACKAGE	BODY SIZE (NOM)
LM2940-N	SOT-223 (4)	6.50 mm x 3.50 mm
	WSON (8)	4.00 mm x 4.00 mm
	TO-263 (3)	10.18 mm x 8.41 mm
	TO-220 (3)	14.986 mm x 10.16 mm
LM2940C	TO-263 (3)	10.18 mm x 8.41 mm
	TO-220 (3)	14.986 mm x 10.16 mm

(1) For all available packages, see the orderable addendum at the end of the datasheet.

#### Simplified Schematic

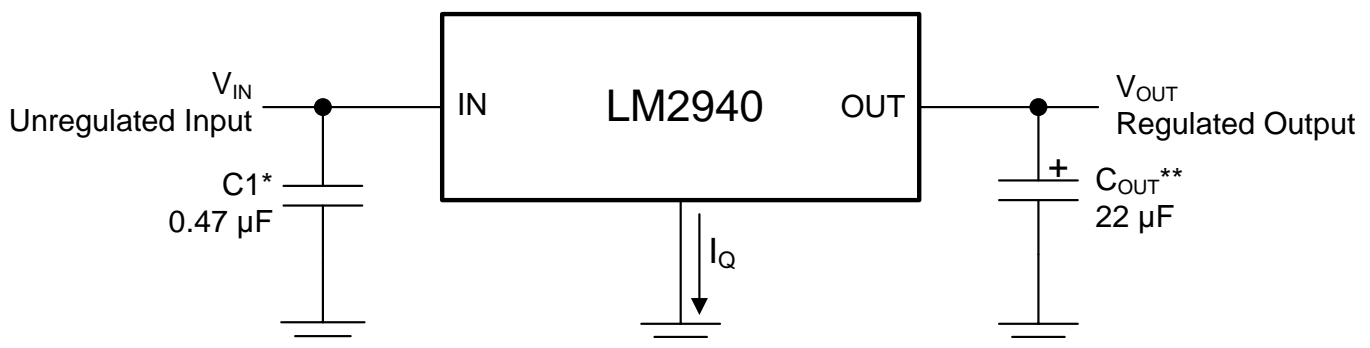

\*Required if regulator is located far from power supply filter.

\*\* $C_{OUT}$  must be at least 22  $\mu$ F to maintain stability. May be increased without bound to maintain regulation during transients. Locate as close as possible to the regulator. This capacitor must be rated over the same operating temperature range as the regulator and the ESR is critical; see curve.



## Table of Contents

<b>1 Features</b> .....	<b>1</b>	7.3 Feature Description .....	<b>13</b>
<b>2 Applications</b> .....	<b>1</b>	7.4 Device Functional Modes .....	<b>14</b>
<b>3 Description</b> .....	<b>1</b>	<b>8 Application and Implementation</b> .....	<b>15</b>
<b>4 Revision History</b> .....	<b>2</b>	8.1 Application Information .....	<b>15</b>
<b>5 Pin Configuration and Functions</b> .....	<b>3</b>	8.2 Typical Application .....	<b>15</b>
<b>6 Specifications</b> .....	<b>4</b>	<b>9 Power Supply Recommendations</b> .....	<b>17</b>
6.1 Absolute Maximum Ratings .....	<b>4</b>	<b>10 Layout</b> .....	<b>17</b>
6.2 ESD Ratings .....	<b>4</b>	10.1 Layout Guidelines .....	<b>17</b>
6.3 Recommended Operating Conditions .....	<b>4</b>	10.2 Layout Examples .....	<b>17</b>
6.4 Thermal Information .....	<b>5</b>	10.3 Heatsinking .....	<b>18</b>
6.5 Electrical Characteristics (5 V and 8 V) .....	<b>5</b>	<b>11 Device and Documentation Support</b> .....	<b>20</b>
6.6 Electrical Characteristics (9 V and 10 V) .....	<b>6</b>	11.1 Documentation Support .....	<b>20</b>
6.7 Electrical Characteristics (12 V and 15 V) .....	<b>7</b>	11.2 Related Links .....	<b>20</b>
6.8 Typical Characteristics .....	<b>8</b>	11.3 Trademarks .....	<b>20</b>
<b>7 Detailed Description</b> .....	<b>13</b>	11.4 Electrostatic Discharge Caution .....	<b>20</b>
7.1 Overview .....	<b>13</b>	11.5 Glossary .....	<b>20</b>
7.2 Functional Block Diagram .....	<b>13</b>	<b>12 Mechanical, Packaging, and Orderable Information</b> .....	<b>20</b>

## 4 Revision History

NOTE: Page numbers for previous revisions may differ from page numbers in the current version.

<b>Changes from Revision I (April 2013) to Revision J</b>	<b>Page</b>
• Added <i>Pin Configuration and Functions</i> section, <i>ESD Rating</i> table, <i>Feature Description</i> section, <i>Device Functional Modes</i> , <i>Application and Implementation</i> section, <i>Power Supply Recommendations</i> section, <i>Layout</i> section, <i>Device and Documentation Support</i> section, and <i>Mechanical, Packaging, and Orderable Information</i> section .....	<b>1</b>
• Deleted information re: obsolete CDIP and CLGA package options ; Change pin names from Vin, Vout to IN, OUT; delete Heatsinking sections re: packages apart from TO-220 .....	<b>1</b>
• Changed symbols for Thermal Information .....	<b>19</b>

<b>Changes from Revision H (April 2013) to Revision I</b>	<b>Page</b>
---	-------------

## 5 Pin Configuration and Functions

**DDPAK/TO-263 (KTT) Package  
3 Pins  
Top View**



**TO-220 (NDE) Package  
4 Pins  
Front View**

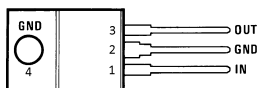

**SOT-223 (DCY) Package  
3 Pins  
Front View**

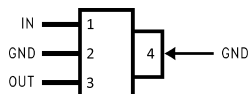

**DDPAK/TO-263 ( KTT) Package  
Side View**



**WSON (NGN) Package  
8 Pins  
Top View**

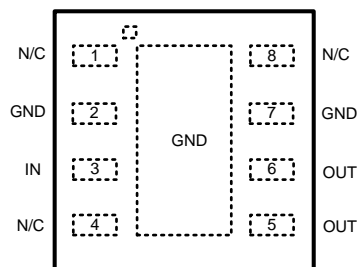

Pin 2 and pin 7 are fused to center DAP  
Pin 5 and 6 need to be tied together on PCB board

### Pin Functions

NAME	PIN				I/O	DESCRIPTION
	NDE	KTT	DCY	NGN		
IN	1	1	1	3	I	Unregulated input voltage.
GND	2	2	2	2	—	Ground
OUT	3	3	3	5, 6	O	Regulated output voltage. This pin requires an output capacitor to maintain stability. See <a href="#">Detailed Design Procedure</a> for output capacitor details.
GND	4	4	4	7	—	Ground
N/C	—	—	—	1, 4, 8	—	No connection

## 6 Specifications

### 6.1 Absolute Maximum Ratings<sup>(1)(2)</sup>

		MIN	MAX	UNIT
LM2940-N KTT, NDE, DCY $\leq$ 100 ms			60	V
LM2940C KTT, NDE $\leq$ 1 ms			45	
Internal power dissipation <sup>(3)</sup>			Internally Limited	
Maximum junction temperature			150	°C
Soldering temperature <sup>(4)</sup>	TO-220 (NDE), Wave (10 s)		260	
	DDPAK/TO-263 (KTT) (30 s)		235	
	SOT-223 (DCY) (30 s)		260	
	WSON-8 (NGN) (30 s)		235	
Storage temperature, $T_{stg}$		-65	150	

- (1) Absolute Maximum Ratings are limits beyond which damage to the device may occur. *Recommended Operating Conditions* are conditions under which the device functions but the specifications might not be ensured. For ensured specifications and test conditions see the *Electrical Characteristics (5 V and 8 V)*.
- (2) If Military/Aerospace specified devices are required, please contact the Texas Instruments Sales Office/ Distributors for availability and specifications.
- (3) The maximum allowable power dissipation is a function of the maximum junction temperature,  $T_J$ , the junction-to-ambient thermal resistance,  $R_{\theta JA}$ , and the ambient temperature,  $T_A$ . Exceeding the maximum allowable power dissipation will cause excessive die temperature, and the regulator will go into thermal shutdown. The value of  $R_{\theta JA}$  (for devices in still air with no heatsink) is 23.3°C/W for the TO-220 package, 40.9°C/W for the DDPK/TO-263 package, and 59.3°C/W for the SOT-223 package. The effective value of  $R_{\theta JA}$  can be reduced by using a heatsink (see *Heatsinking* for specific information on heatsinking). The value of  $R_{\theta JA}$  for the WSON package is specifically dependent on PCB trace area, trace material, and the number of layers and thermal vias. For improved thermal resistance and power dissipation for the WSON package, refer to Application Note AN-1187 *Leadless Leadframe Package (LLP) (SNOA401)*. It is recommended that 6 vias be placed under the center pad to improve thermal performance.
- (4) Refer to JEDEC J-STD-020C for surface mount device (SMD) package reflow profiles and conditions. Unless otherwise stated, the temperature and time are for Sn-Pb (STD) only.

### 6.2 ESD Ratings

		VALUE	UNIT
$V_{(ESD)}$	Electrostatic discharge	Human-body model (HBM), per ANSI/ESDA/JEDEC JS-001 <sup>(1)</sup>	$\pm 2000$ V

- (1) JEDEC document JEP155 states that 500-V HBM allows safe manufacturing with a standard ESD control process.

### 6.3 Recommended Operating Conditions

over operating free-air temperature range (unless otherwise noted)

		MIN	MAX	UNIT
Input voltage		6	26	V
Temperature	LM2940-N NDE, LM2940-N KTT	-40	125	°C
	LM2940C NDE, LM2940C KTT	0	125	
	LM2940-N DCY	-40	85	
	LM2940-N NGN	-40	125	

## 6.4 Thermal Information

THERMAL METRIC <sup>(1)</sup>		LM2940-N, LM2940C		LM2940-N		UNIT
		TO-220 (NDE)	DDPAK/TO-263 (KTT)	SOT-223 (DCY)	WSO (NGN)	
		3 PINS	3 PINS	4 PINS	8 PINS	
R <sub>θJA</sub>	Junction-to-ambient thermal resistance <sup>(2)</sup>	23.3	40.9	59.3	40.5	°C/W
R <sub>θJC(top)</sub>	Junction-to-case (top) thermal resistance	16.1	43.5	38.9	26.2	
R <sub>θJB</sub>	Junction-to-board thermal resistance	4.8	23.5	8.1	17.0	
Ψ <sub>JT</sub>	Junction-to-top characterization parameter	2.7	10.3	1.7	0.2	
Ψ <sub>JB</sub>	Junction-to-board characterization parameter	4.8	22.5	8.0	17.2	
R <sub>θJC(bot)</sub>	Junction-to-case (bottom) thermal resistance	1.1	0.8	n/a	3.2	

(1) For more information about traditional and new thermal metrics, see the *IC Package Thermal Metrics* application report, [SPRA953](#).

(2) Thermal information for the TO-220 package is for a package vertically mounted with a heat sink in the middle of a PCB which is compliant to the JEDEC HIGH-K 2s2p (JESD51-7). The heatsink-to-ambient thermal resistance, R<sub>θSA</sub>, is 21.7°C/W. See [Heatsinking TO-220 Package Parts](#) for more information.

## 6.5 Electrical Characteristics (5 V and 8 V)

Unless otherwise specified: V<sub>IN</sub> = V<sub>OUT</sub> + 5 V, I<sub>OUT</sub> = 1 A and C<sub>OUT</sub> = 22 μF. MIN (minimum) and MAX (maximum) limits apply over the recommended operating temperature range, unless otherwise noted; typical limits apply for T<sub>A</sub> = T<sub>J</sub> = 25°C.

PARAMETER	TEST CONDITIONS	5 V			8 V			UNIT	
		MIN	TYP	MAX	MIN	TYP	MAX		
Input voltage	5 mA ≤ I <sub>OUT</sub> ≤ 1 A	6.25		26	9.4		26	V	
Output voltage	5 mA ≤ I <sub>OUT</sub> ≤ 1 A	4.75	5	5.25	7.6	8	8.4		
		5 mA ≤ I <sub>OUT</sub> ≤ 1 A, T <sub>J</sub> = 25°C	4.85	5	5.15	7.76	8	8.24	
Line regulation	V <sub>OUT</sub> + 2 V ≤ V <sub>IN</sub> ≤ 26 V, I <sub>OUT</sub> = 5 mA T <sub>J</sub> = 25°C		20	50		20	80	mV	
Load regulation	50 mA ≤ I <sub>OUT</sub> ≤ 1 A							mV	
		LM2940-N		35	80		55		130
		LM2940C		35	50		55		80
Output impedance	100 mADC, 20 mArms, f <sub>OUT</sub> = 120 Hz		35			55		mΩ	
Quiescent current	V <sub>OUT</sub> + 2 V ≤ V <sub>IN</sub> ≤ 26 V, I <sub>OUT</sub> = 5 mA							mA	
		LM2940-N		10	20		10		20
		LM2940C		10	15		10		15
		LM2940C		10	15		10		15
	V <sub>IN</sub> = V <sub>OUT</sub> + 5 V, I <sub>OUT</sub> = 1 A		30	60		30	60		
	V <sub>IN</sub> = V <sub>OUT</sub> + 5 V, I <sub>OUT</sub> = 1 A T <sub>J</sub> = 25°C		30	45		30	45		
Output noise voltage	10 Hz to 100 kHz, I <sub>OUT</sub> = 5 mA		150			240		μVrms	
Ripple rejection	f <sub>OUT</sub> = 120 Hz, 1 V <sub>rms</sub> , I <sub>OUT</sub> = 100 mA							dB	
		LM2940-N		54	72		48		66
		LM2940C		60	72		54		66
	f <sub>OUT</sub> = 120 Hz, 1 V <sub>rms</sub> , I <sub>OUT</sub> = 100 mA T <sub>J</sub> = 25°C		60	72		54	66		
Long-term stability			20			32		mV/1000 Hr	
Dropout voltage	I <sub>OUT</sub> = 1 A		0.5	1		0.5	1	V	
	I <sub>OUT</sub> = 1 A, T <sub>J</sub> = 25°C		0.5	0.8		0.5	0.8		
	I <sub>OUT</sub> = 100 mA		110	200		110	200	mV	
	I <sub>OUT</sub> = 100 mA, T <sub>J</sub> = 25°C		110	150		110	150		

## Electrical Characteristics (5 V and 8 V) (continued)

Unless otherwise specified:  $V_{IN} = V_{OUT} + 5\text{ V}$ ,  $I_{OUT} = 1\text{ A}$  and  $C_{OUT} = 22\text{ }\mu\text{F}$ . MIN (minimum) and MAX (maximum) limits apply over the recommended operating temperature range, unless otherwise noted; typical limits apply for  $T_A = T_J = 25^\circ\text{C}$ .

PARAMETER	TEST CONDITIONS		5 V			8 V			UNIT
			MIN	TYP	MAX	MIN	TYP	MAX	
Short-circuit current	See <sup>(1)</sup> , $T_J = 25^\circ\text{C}$		1.6	1.9		1.6	1.9		A
Maximum line transient	$R_{OUT} = 100\text{ }\Omega$ , $T \leq 100\text{ ms}$	LM2940-N	60	75		60	75		V
	$R_{OUT} = 100\text{ }\Omega$ , $T \leq 1\text{ ms}$ $T_J = 25^\circ\text{C}$	LM2940C	45	55		45	55		
Reverse polarity DC input voltage	$R_{OUT} = 100\text{ }\Omega$	LM2940-N	-15	-30		-15	-30		V
	$R_{OUT} = 100\text{ }\Omega$ $T_J = 25^\circ\text{C}$	LM2940C	-15	-30		-15	-30		
Reverse polarity Transient Input Voltage	$R_{OUT} = 100\text{ }\Omega$ , $T \leq 100\text{ ms}$	LM2940-N	-50	-75		-50	-75		V
	$R_{OUT} = 100\text{ }\Omega$ , $T \leq 1\text{ ms}$	LM2940C	-45	-55					

(1) Output current will decrease with increasing temperature but will not drop below 1 A at the maximum specified temperature.

## 6.6 Electrical Characteristics (9 V and 10 V)

Unless otherwise specified:  $V_{IN} = V_{OUT} + 5\text{ V}$ ,  $I_{OUT} = 1\text{ A}$  and  $C_{OUT} = 22\text{ }\mu\text{F}$ . MIN (minimum) and MAX (maximum) limits apply over the recommended operating temperature range, unless otherwise noted; typical limits apply for  $T_A = T_J = 25^\circ\text{C}$ .

PARAMETER	TEST CONDITIONS		9 V			10 V			UNIT
			MIN	TYP	MAX	MIN	TYP	MAX	
Input voltage	$5\text{ mA} \leq I_{OUT} \leq 1\text{ A}$		10.5		26	11.5		26	V
Output voltage	$5\text{ mA} \leq I_{OUT} \leq 1\text{ A}$		8.55	9	9.45	9.5	10	10.5	
		$5\text{ mA} \leq I_{OUT} \leq 1\text{ A}$ , $T_J = 25^\circ\text{C}$		8.73	9	9.27	9.7	10	10.3
Line regulation	$V_{OUT} + 2\text{ V} \leq V_{IN} \leq 26\text{ V}$ , $I_{OUT} = 5\text{ mA}$ $T_J = 25^\circ\text{C}$			20	90		20	100	mV
Load regulation	$50\text{ mA} \leq I_{OUT} \leq 1\text{ A}$	LM2940-N		60	150		65	165	mV
	$50\text{ mA} \leq I_{OUT} \leq 1\text{ A}$ $T_J = 25^\circ\text{C}$	LM2940-N		60	90		65	100	
		LM2940C		60	90				
Output impedance	100 mADC, 20 mArms, $f_{OUT} = 120\text{ Hz}$			60			65		m $\Omega$
Quiescent current	$V_{OUT} + 2\text{ V} \leq V_{IN} \leq 26\text{ V}$ , $I_{OUT} = 5\text{ mA}$	LM2940-N		10	20		10	20	mA
	$V_{OUT} + 2\text{ V} \leq V_{IN} \leq 26\text{ V}$ , $I_{OUT} = 5\text{ mA}$ $T_J = 25^\circ\text{C}$	LM2940-N		10	15			15	
		LM2940C		10	15				
	$V_{IN} = V_{OUT} + 5\text{ V}$ , $I_{OUT} = 1\text{ A}$			30	60		30	60	
$V_{IN} = V_{OUT} + 5\text{ V}$ , $I_{OUT} = 1\text{ A}$ $T_J = 25^\circ\text{C}$			30	45		30	45		
Output noise voltage	10 Hz to 100 kHz, $I_{OUT} = 5\text{ mA}$			270			300		$\mu\text{Vrms}$
Ripple rejection	$f_{OUT} = 120\text{ Hz}$ , $1\text{ V}_{\text{rms}}$ $I_{OUT} = 100\text{ mA}$	LM2940-N	46	64		45	63		dB
	$f_{OUT} = 120\text{ Hz}$ , $1\text{ V}_{\text{rms}}$ $I_{OUT} = 100\text{ mA}$ $T_J = 25^\circ\text{C}$	LM2940-N	52	64		51	63		
		LM2940C	52	64					
Long-term stability				34			36		mV/1000 Hr
Dropout voltage	$I_{OUT} = 1\text{ A}$			0.5	1		0.5	1	V
	$I_{OUT} = 1\text{ A}$ , $T_J = 25^\circ\text{C}$			0.5	0.8		0.5	0.8	
	$I_{OUT} = 100\text{ mA}$			110	200		110	200	mV
	$I_{OUT} = 100\text{ mA}$ , $T_J = 25^\circ\text{C}$			110	150		110	150	

## Electrical Characteristics (9 V and 10 V) (continued)

Unless otherwise specified:  $V_{IN} = V_{OUT} + 5\text{ V}$ ,  $I_{OUT} = 1\text{ A}$  and  $C_{OUT} = 22\text{ }\mu\text{F}$ . MIN (minimum) and MAX (maximum) limits apply over the recommended operating temperature range, unless otherwise noted; typical limits apply for  $T_A = T_J = 25^\circ\text{C}$ .

PARAMETER	TEST CONDITIONS		9 V			10 V			UNIT
			MIN	TYP	MAX	MIN	TYP	MAX	
Short-circuit current	See <sup>(1)</sup> , $T_J = 25^\circ\text{C}$		1.6	1.9		1.6	1.9		A
Maximum line transient	$R_{OUT} = 100\text{ }\Omega$ , $T \leq 100\text{ ms}$	LM2940-N	60	75		60	75		V
	$R_{OUT} = 100\text{ }\Omega$ , $T \leq 100\text{ ms}$ $T_J = 25^\circ\text{C}$	LM2940C	45	55					
Reverse polarity DC input voltage	$R_{OUT} = 100\text{ }\Omega$	LM2940-N	-15	-30		-15	-30		V
	$R_{OUT} = 100\text{ }\Omega$ $T_J = 25^\circ\text{C}$	LM2940C	-15	-30					
Reverse polarity Transient Input Voltage	$R_{OUT} = 100\text{ }\Omega$ , $T \leq 100\text{ ms}$	LM2940-N	-50	-75		-50	-75		V
		LM2940C	-45	-55					

(1) Output current will decrease with increasing temperature but will not drop below 1 A at the maximum specified temperature.

## 6.7 Electrical Characteristics (12 V and 15 V)

Unless otherwise specified:  $V_{IN} = V_{OUT} + 5\text{ V}$ ,  $I_{OUT} = 1\text{ A}$  and  $C_{OUT} = 22\text{ }\mu\text{F}$ . MIN (minimum) and MAX (maximum) limits apply over the recommended operating temperature range, unless otherwise noted; typical limits apply for  $T_A = T_J = 25^\circ\text{C}$ .

PARAMETER	TEST CONDITIONS		12 V			15 V			UNIT
			MIN	TYP	MAX	MIN	TYP	MAX	
Input voltage	$5\text{ mA} \leq I_{OUT} \leq 1\text{ A}$		13.6		26	16.75		26	V
Output voltage	$5\text{ mA} \leq I_{OUT} \leq 1\text{ A}$		11.40	12	12.6	14.25	15	15.75	
		$5\text{ mA} \leq I_{OUT} \leq 1\text{ A}$ , $T_J = 25^\circ\text{C}$		11.64	12	12.36	14.55	15	15.45
Line regulation	$V_{OUT} + 2\text{ V} \leq V_{IN} \leq 26\text{ V}$ , $I_{OUT} = 5\text{ mA}$ $T_J = 25^\circ\text{C}$			20	120		20	150	mV
Load regulation	$50\text{ mA} \leq I_{OUT} \leq 1\text{ A}$	LM2940-N		55	200				mV
	$50\text{ mA} \leq I_{OUT} \leq 1\text{ A}$ $T_J = 25^\circ\text{C}$	LM2940-N		55	120				
		LM2940C		55	120		70	150	
Output impedance	100 mADC, 20 mArms, $f_{OUT} = 120\text{ Hz}$			80			100		m $\Omega$
Quiescent current	$V_{OUT} + 2\text{ V} \leq V_{IN} \leq 26\text{ V}$ , $I_{OUT} = 5\text{ mA}$	LM2940-N		10	20				mA
	$V_{OUT} + 2\text{ V} \leq V_{IN} \leq 26\text{ V}$ , $I_{OUT} = 5\text{ mA}$ $T_J = 25^\circ\text{C}$	LM2940-N		10	15				
		LM2940C		10	15		10	15	
	$V_{IN} = V_{OUT} + 5\text{ V}$ , $I_{OUT} = 1\text{ A}$			30	60		30	60	
	$V_{IN} = V_{OUT} + 5\text{ V}$ , $I_{OUT} = 1\text{ A}$ $T_J = 25^\circ\text{C}$			30	45		30	45	
Output noise voltage	10 Hz to 100 kHz, $I_{OUT} = 5\text{ mA}$			360			450		$\mu\text{Vrms}$
Ripple rejection	$f_{OUT} = 120\text{ Hz}$ , $1\text{ Vrms}$ , $I_{OUT} = 100\text{ mA}$	LM2940-N	48	66					dB
	$f_{OUT} = 120\text{ Hz}$ , $1\text{ Vrms}$ , $I_{OUT} = 100\text{ mA}$ $T_J = 25^\circ\text{C}$	LM2940-N	54	66					
		LM2940C	54	66		52	64		
Long-term stability				48			60		mV/1000 Hr
Dropout voltage	$I_{OUT} = 1\text{ A}$			0.5	1		0.5	1	V
	$I_{OUT} = 1\text{ A}$ , $T_J = 25^\circ\text{C}$			0.5	0.8		0.5	0.8	
	$I_{OUT} = 100\text{ mA}$			110	200		110	200	mV
	$I_{OUT} = 100\text{ mA}$ , $T_J = 25^\circ\text{C}$			110	150		110	150	

### Electrical Characteristics (12 V and 15 V) (continued)

Unless otherwise specified:  $V_{IN} = V_{OUT} + 5\text{ V}$ ,  $I_{OUT} = 1\text{ A}$  and  $C_{OUT} = 22\text{ }\mu\text{F}$ . MIN (minimum) and MAX (maximum) limits apply over the recommended operating temperature range, unless otherwise noted; typical limits apply for  $T_A = T_J = 25^\circ\text{C}$ .

PARAMETER	TEST CONDITIONS		12 V			15 V			UNIT
			MIN	TYP	MAX	MIN	TYP	MAX	
Short-circuit current	See <sup>(1)</sup> , $T_J = 25^\circ\text{C}$		1.6	1.9		1.6	1.9	A	
Maximum line transient	$R_{OUT} = 100\text{ }\Omega$ , $T \leq 100\text{ ms}$	LM2940-N	60	75				V	
	$R_{OUT} = 100\text{ }\Omega$ , $T \leq 100\text{ ms}$ $T_J = 25^\circ\text{C}$	LM2940C	45	55		45	55		
Reverse polarity DC input voltage	$R_{OUT} = 100\text{ }\Omega$	LM2940-N	-15	-30				V	
	$R_{OUT} = 100\text{ }\Omega$ $T_J = 25^\circ\text{C}$	LM2940C	-15	-30		-15	-30		
Reverse polarity transient input voltage	$R_{OUT} = 100\text{ }\Omega$ , $T \leq 100\text{ ms}$	LM2940-N	-50	-75				V	
	$R_{OUT} = 100\text{ }\Omega$ , $T \leq 1\text{ ms}$	LM2940C	-45	-55		-45	-55		

(1) Output current will decrease with increasing temperature but will not drop below 1 A at the maximum specified temperature.

### 6.8 Typical Characteristics

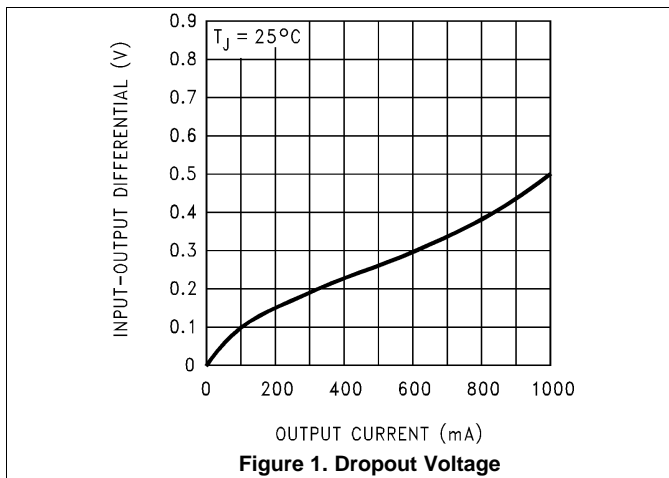

Figure 1. Dropout Voltage

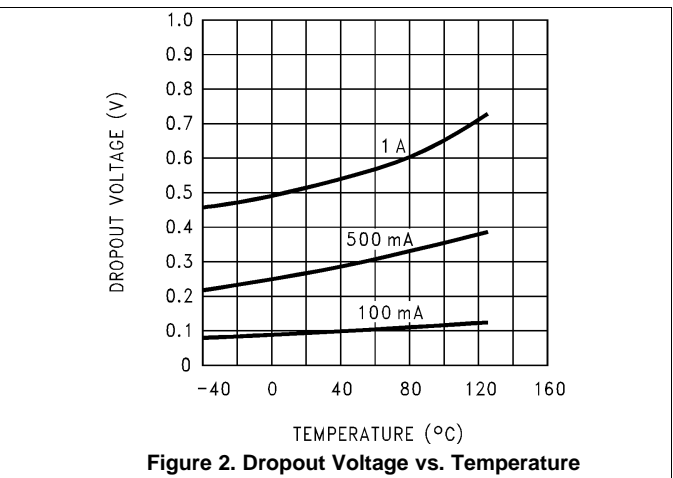

Figure 2. Dropout Voltage vs. Temperature

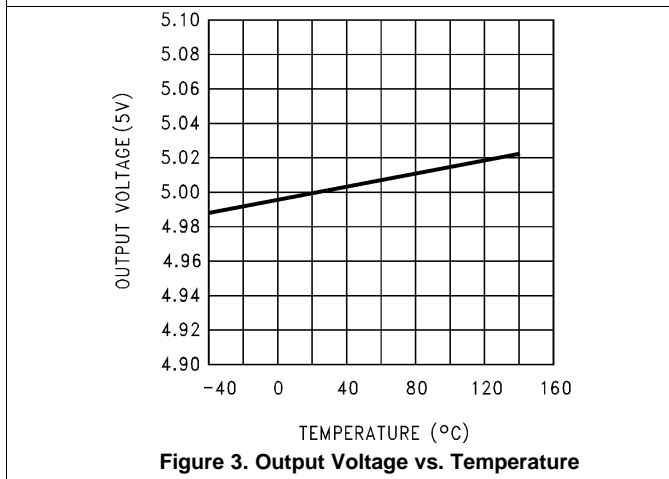

Figure 3. Output Voltage vs. Temperature

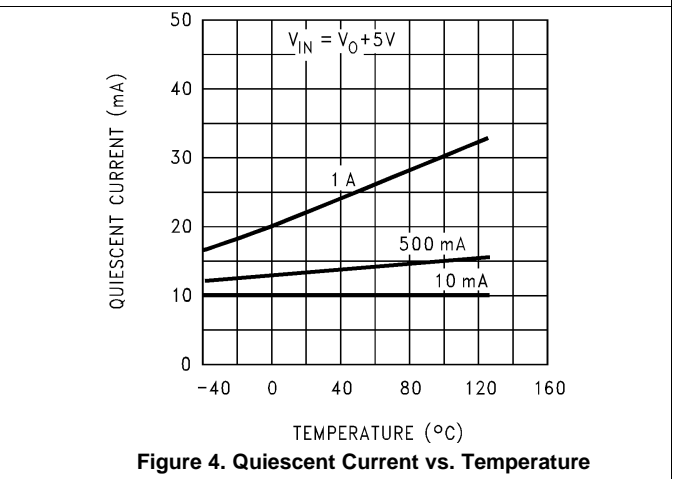

Figure 4. Quiescent Current vs. Temperature



Typical Characteristics (continued)



Figure 5. Quiescent Current

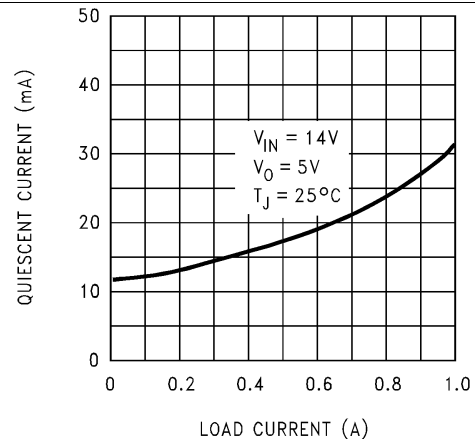

Figure 6. Quiescent Current

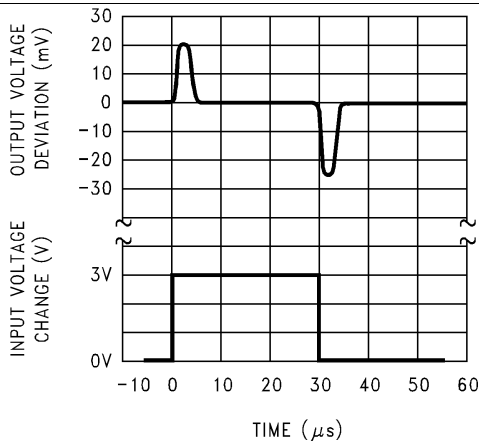

Figure 7. Line Transient Response

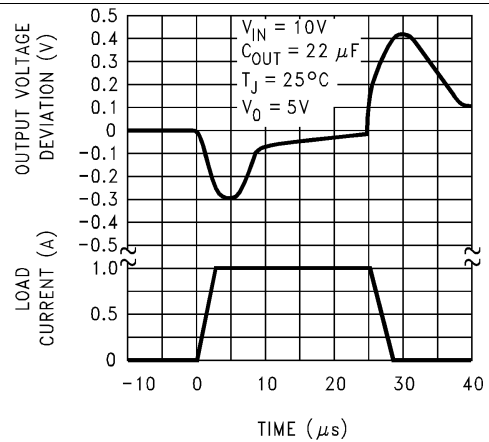

Figure 8. Load Transient Response



Figure 9. Ripple Rejection

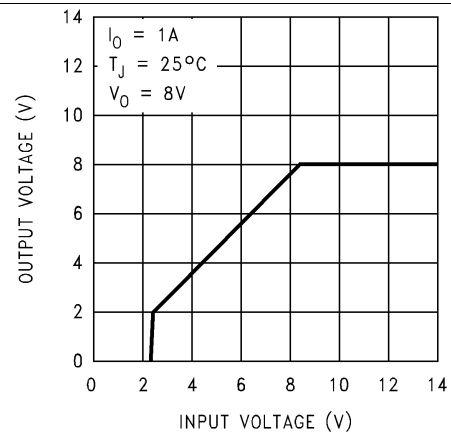

Figure 10. Low Voltage Behavior

**Typical Characteristics (continued)**

**Figure 11. Low Voltage Behavior**

**Figure 12. Low Voltage Behavior**

**Figure 13. Low Voltage Behavior**

**Figure 14. Low Voltage Behavior**

**Figure 15. Output at Voltage Extremes**

**Figure 16. Output at Voltage Extremes**

Typical Characteristics (continued)



Figure 17. Output at Voltage Extremes



Figure 18. Output at Voltage Extremes

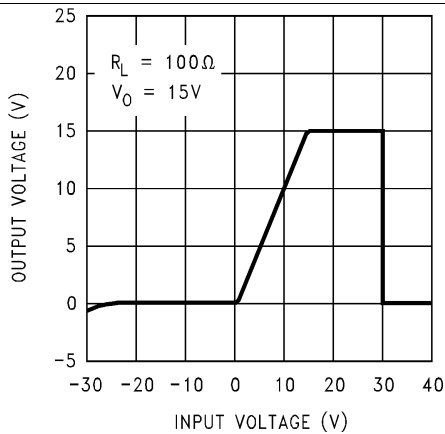

Figure 19. Output at Voltage Extremes

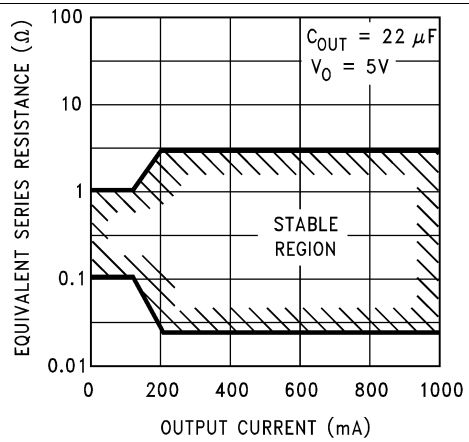

Figure 20. Output Capacitor ESR

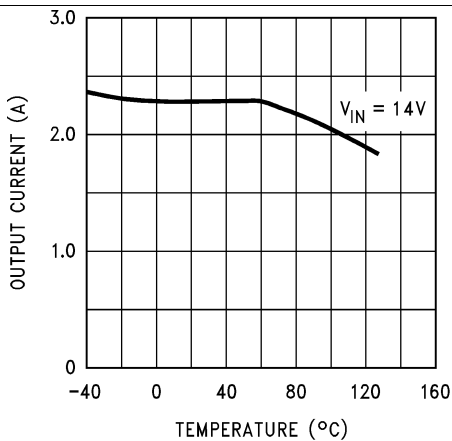

Figure 21. Peak Output Current

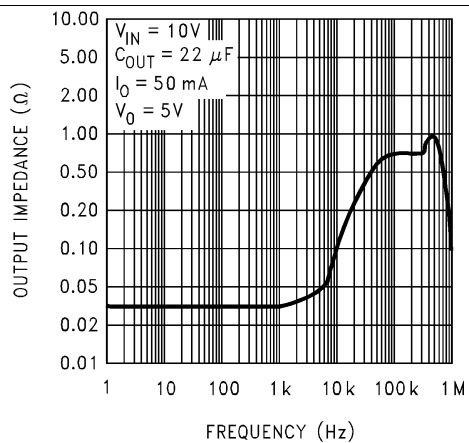

Figure 22. Output Impedance

Typical Characteristics (continued)

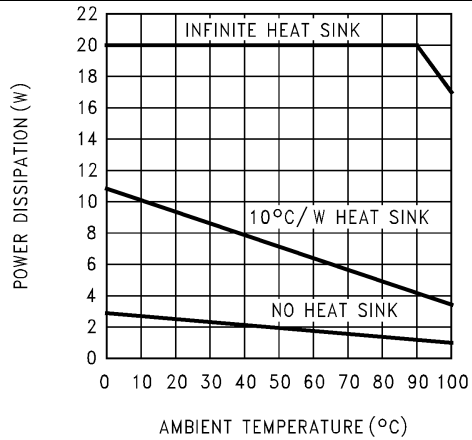

Figure 23. Maximum Power Dissipation (TO-220)

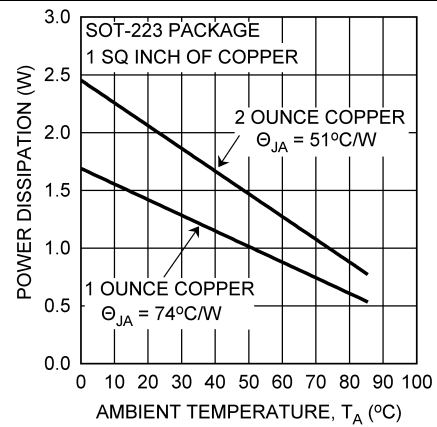

Figure 24. Maximum Power Dissipation (SOT-223)



Figure 25. Maximum Power Dissipation (DDPAK/TO-263)

## 7 Detailed Description

### 7.1 Overview

The LM2940 positive voltage regulator features the ability to source 1 A of output current with a dropout voltage of typically 0.5 V and a maximum of 1 V over the entire temperature range. Furthermore, a quiescent current reduction circuit has been included which reduces the ground current when the differential between the input voltage and the output voltage exceeds approximately 3 V. The quiescent current with 1 A of output current and an input-output differential of 5 V is therefore only 30 mA. Higher quiescent currents only exist when the regulator is in the dropout mode ( $V_{IN} - V_{OUT} \leq 3$  V).

### 7.2 Functional Block Diagram



### 7.3 Feature Description

#### 7.3.1 Short-Circuit Current Limit

The internal current limit circuit is used to protect the LDO against high-load current faults or shorting events. The LDO is not designed to operate in a steady-state current limit. During a current-limit event, the LDO sources constant current. Therefore, the output voltage falls when load impedance decreases. Note, also, that if a current limit occurs and the resulting output voltage is low, excessive power may be dissipated across the LDO, resulting a thermal shutdown of the output.

#### 7.3.2 Overvoltage Shutdown (OVSD)

Input voltage greater than typically 30 V will cause the LM2940 output to be disabled. When operating with the input voltage greater than the maximum recommended input voltage of 26 V, the device performance is not ensured. Continuous operation with the input voltage greater than the maximum recommended input voltage is discouraged.

#### 7.3.3 Thermal Shutdown (TSD)

The LM2940 contains the thermal shutdown circuitry to turn off the output when excessive heat is dissipated in the LDO. The internal protection circuitry of the LM2940 is designed to protect against thermal overload conditions. The TSD circuitry is not intended to replace proper heat sinking. Continuously running the device into thermal shutdown degrades its reliability as the junction temperature will be exceeding the absolute maximum junction temperature rating.

## 7.4 Device Functional Modes

### 7.4.1 Operation with Enable Control

The LM2940 design does not include any undervoltage lockout (UVLO), or enable functions. Generally, the output voltage will track the input voltage until the input voltage is greater than  $V_{OUT} + 1V$ . When the input voltage is greater than  $V_{OUT} + 1V$ , the LM2940 will be in linear operation, and the output voltage will be regulated. However, the device will be sensitive to any small perturbation of the input voltage. Device dynamic performance is improved when the input voltage is at least 2 V greater than the output voltage.

## 8 Application and Implementation

### NOTE

Information in the following applications sections is not part of the TI component specification, and TI does not warrant its accuracy or completeness. TI's customers are responsible for determining suitability of components for their purposes. Customers should validate and test their design implementation to confirm system functionality.

### 8.1 Application Information

The LM2940-N and LM2940C positive voltage regulators feature the ability to source 1 A of output current with a dropout voltage of typically 0.5 V and a maximum of 1 V over the entire temperature range. The output capacitor,  $C_{OUT}$ , must have a capacitance value of at least 22  $\mu\text{F}$  with an ESR of at least 100 m $\Omega$ , but no more than 1  $\Omega$ . The minimum capacitance value and the ESR requirements apply across the entire expected operating ambient temperature range.

### 8.2 Typical Application



\*Required if regulator is located far from power supply filter.

\*\* $C_{OUT}$  must be at least 22  $\mu\text{F}$  to maintain stability. May be increased without bound to maintain regulation during transients. Locate as close as possible to the regulator. This capacitor must be rated over the same operating temperature range as the regulator and the ESR is critical; see curve.

Figure 26. Typical Application

#### 8.2.1 Design Requirements

Table 1. Design Parameters

DESIGN PARAMETER	EXAMPLE VALUE
Input voltage range	6 V to 26 V
Output voltage range	8 V
Output current range	5 mA to 1 A
Input capacitor value	0.47 $\mu\text{F}$
Output capacitor value	22 $\mu\text{F}$ minimum
Output capacitor ESR range	100 m $\Omega$ to 1 $\Omega$

#### 8.2.2 Detailed Design Procedure

##### 8.2.2.1 External Capacitors

The output capacitor is critical to maintaining regulator stability, and must meet the required conditions for both equivalent series resistance (ESR) and minimum amount of capacitance.

##### 8.2.2.1.1 Minimum Capacitance

The minimum output capacitance required to maintain stability is 22  $\mu\text{F}$  (this value may be increased without limit). Larger values of output capacitance will give improved transient response.

### 8.2.2.1.2 ESR Limits

The ESR of the output capacitor will cause loop instability if it is too high or too low. The acceptable range of ESR plotted versus load current is shown in the graph below. *It is essential that the output capacitor meet these requirements, or oscillations can result.*

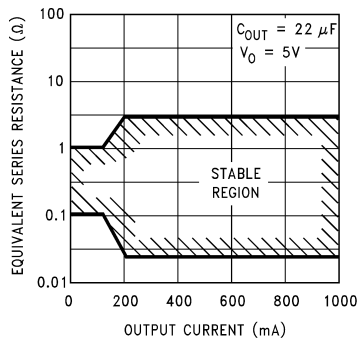

Figure 27. Output Capacitor ESR Limits

It is important to note that for most capacitors, ESR is specified only at room temperature. However, the designer must ensure that the ESR will stay inside the limits shown over the entire operating temperature range for the design.

For aluminum electrolytic capacitors, ESR will increase by about 30X as the temperature is reduced from 25°C to -40°C. This type of capacitor is not well-suited for low temperature operation.

Solid tantalum capacitors have a more stable ESR over temperature, but are more expensive than aluminum electrolytics. A cost-effective approach sometimes used is to parallel an aluminum electrolytic with a solid tantalum, with the total capacitance split about 75/25% with the aluminum being the larger value.

If two capacitors are paralleled, the effective ESR is the parallel of the two individual values. The flatter ESR of the tantalum will keep the effective ESR from rising as quickly at low temperatures.

### 8.2.3 Application Curves

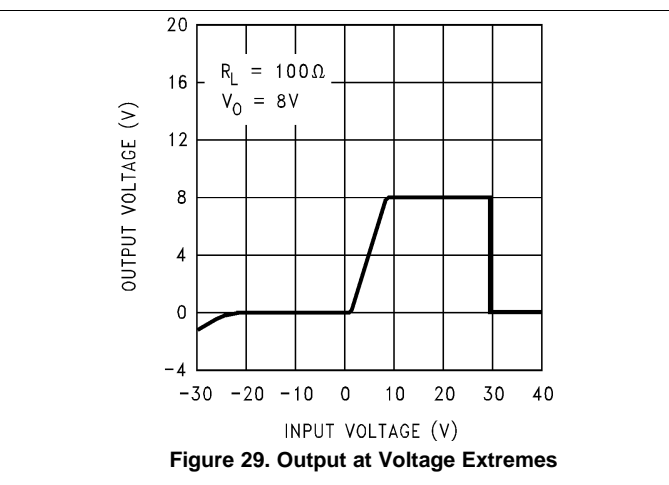
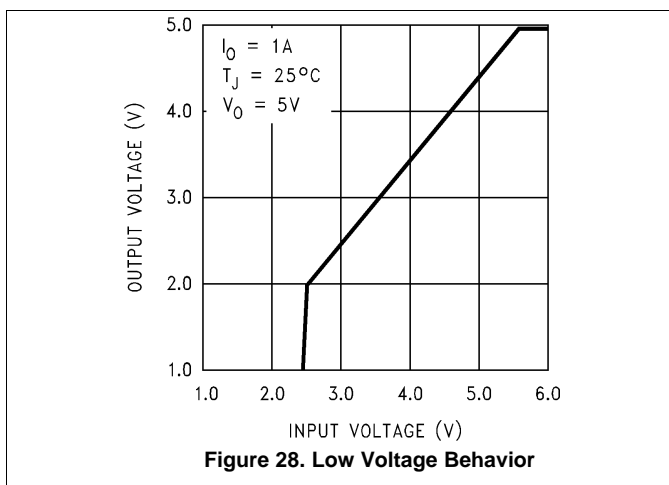



## 9 Power Supply Recommendations

The device is designed to operate from an input voltage supply range between  $V_{OUT} + 1\text{ V}$  up to a maximum of 26 V. This input supply must be well regulated and free of spurious noise. To ensure that the LM2940 output voltage is well regulated, the input supply should be at least  $V_{OUT} + 2\text{ V}$ .

## 10 Layout

### 10.1 Layout Guidelines

The dynamic performance of the LM2940 is dependent on the layout of the PCB. PCB layout practices that are adequate for typical LDOs may degrade the PSRR, noise, or transient performance of the LM2940. Best performance is achieved by placing  $C_{IN}$  and  $C_{OUT}$  on the same side of the PCB as the LM2940, and as close as is practical to the package. The ground connections for  $C_{IN}$  and  $C_{OUT}$  should be back to the LM2940 ground pin using as wide and short of a copper trace as is practical.

### 10.2 Layout Examples



**Figure 30. LM2940 WSON Layout**



**Figure 31. LM2940 SOT-223 Layout**



**Figure 32. TO-263 Layout**

### 10.3 Heatsinking

A heatsink may be required depending on the maximum power dissipation and maximum ambient temperature of the application. Under all possible operating conditions, the junction temperature must be within the range specified under [Absolute Maximum Ratings](#)<sup>(1)(2)</sup>.

To determine if a heatsink is required, the power dissipated by the regulator,  $P_D$ , must be calculated.

Figure 33 shows the voltages and currents which are present in the circuit, as well as the formula for calculating the power dissipated in the regulator:

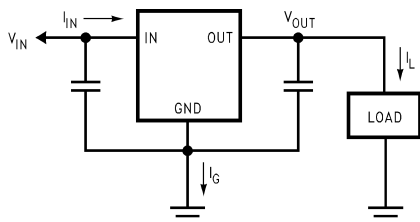

$$I_{IN} = I_L + I_G$$

$$P_D = (V_{IN} - V_{OUT}) I_L + (V_{IN}) I_G$$

**Figure 33. Power Dissipation Diagram**

The next parameter which must be calculated is the maximum allowable temperature rise,  $T_{R(MAX)}$ . This is calculated by using the formula:

$$T_{R(MAX)} = T_{J(MAX)} - T_{A(MAX)}$$

where

- $T_{J(MAX)}$  is the maximum allowable junction temperature, which is 125°C for commercial grade parts.
- $T_{A(MAX)}$  is the maximum ambient temperature which will be encountered in the application. (1)

Using the calculated values for  $T_{R(MAX)}$  and  $P_D$ , the maximum allowable value for the junction-to-ambient thermal resistance,  $R_{\theta JA}$ , can now be found:

$$R_{\theta JA} = T_{R(MAX)} / P_D \quad (2)$$

#### NOTE

If the maximum allowable value for  $R_{\theta JA}$  is found to be  $\geq 23.3^\circ\text{C/W}$  for the TO-220 package (with a heatsink of  $21.7^\circ\text{C/W}$   $R_{\theta SA}$ ),  $\geq 40.9^\circ\text{C/W}$  for the DPAK/TO-263 package, or  $\geq 59.3^\circ\text{C/W}$  for the SOT-223 package, no heatsink is needed since the package alone will dissipate enough heat to satisfy these requirements.

If the calculated value for  $R_{\theta JA}$  falls below these limits, a heatsink is required.

- (1) Absolute Maximum Ratings are limits beyond which damage to the device may occur. [Recommended Operating Conditions](#) are conditions under which the device functions but the specifications might not be ensured. For ensured specifications and test conditions see the [Electrical Characteristics \(5 V and 8 V\)](#).
- (2) If Military/Aerospace specified devices are required, please contact the Texas Instruments Sales Office/ Distributors for availability and specifications.

## Heatsinking (continued)

### 10.3.1 Heatsinking TO-220 Package Parts

The TO-220 can be attached to a typical heatsink, or secured to a copper plane on a PC board.

If a manufactured heatsink is to be selected, the value of heatsink-to-ambient thermal resistance,  $R_{\theta SA}$ , must first be calculated:

$$R_{\theta SA} = R_{\theta JA} - R_{\theta CS} - R_{\theta JC}$$

where

- $R_{\theta JC}$  is defined as the thermal resistance from the junction to the surface of the case. A value of 3°C/W can be assumed for  $R_{\theta JC}$  for this calculation.
- $R_{\theta CS}$  is defined as the thermal resistance between the case and the surface of the heatsink. The value of  $R_{\theta CS}$  will vary from about 0.5°C/W to about 2.5°C/W (depending on method of attachment, insulator, etc.). If the exact value is unknown, 2°C/W should be assumed for  $R_{\theta CS}$ . (3)

When a value for  $R_{\theta SA}$  is found using [Equation 3](#), a heatsink must be selected that has a value that is less than or equal to this number.

$R_{\theta SA}$  is specified numerically by the heatsink manufacturer in the catalog, or shown in a curve that plots temperature rise vs power dissipation for the heatsink.

## 11 Device and Documentation Support

### 11.1 Documentation Support

#### 11.1.1 Related Documentation

For related documentation see the following:

- Application Note AN-1028 *Maximum Power Enhancement Techniques for Power Packages* ([SNVA036](#)).
- Application Note AN-1187 *Leadless Leadframe Package (LLP)* ([SNOA401](#)).

### 11.2 Related Links

The table below lists quick access links. Categories include technical documents, support and community resources, tools and software, and quick access to sample or buy.

**Table 2. Related Links**

PARTS	PRODUCT FOLDER	SAMPLE & BUY	TECHNICAL DOCUMENTS	TOOLS & SOFTWARE	SUPPORT & COMMUNITY
LM2940-N	<a href="#">Click here</a>	<a href="#">Click here</a>	<a href="#">Click here</a>	<a href="#">Click here</a>	<a href="#">Click here</a>
LM2940C	<a href="#">Click here</a>	<a href="#">Click here</a>	<a href="#">Click here</a>	<a href="#">Click here</a>	<a href="#">Click here</a>

### 11.3 Trademarks

All trademarks are the property of their respective owners.

### 11.4 Electrostatic Discharge Caution



These devices have limited built-in ESD protection. The leads should be shorted together or the device placed in conductive foam during storage or handling to prevent electrostatic damage to the MOS gates.

### 11.5 Glossary

[SLYZ022](#) — *TI Glossary*.

This glossary lists and explains terms, acronyms, and definitions.

## 12 Mechanical, Packaging, and Orderable Information

The following pages include mechanical, packaging, and orderable information. This information is the most current data available for the designated devices. This data is subject to change without notice and revision of this document. For browser-based versions of this data sheet, refer to the left-hand navigation.

**PACKAGING INFORMATION**

Orderable Device	Status (1)	Package Type	Package Drawing	Pins	Package Qty	Eco Plan (2)	Lead/Ball Finish (6)	MSL Peak Temp (3)	Op Temp (°C)	Device Marking (4/5)	Samples
LM2940CS-12	NRND	DDPAK/ TO-263	KTT	3	45	TBD	Call TI	Call TI	0 to 125	LM2940CS -12 P+	
LM2940CS-12/NOPB	ACTIVE	DDPAK/ TO-263	KTT	3	45	Pb-Free (RoHS Exempt)	CU SN	Level-3-245C-168 HR	0 to 125	LM2940CS -12 P+	<a href="#">Samples</a>
LM2940CS-15	NRND	DDPAK/ TO-263	KTT	3	45	TBD	Call TI	Call TI	0 to 125	LM2940CS -15 P+	
LM2940CS-15/NOPB	ACTIVE	DDPAK/ TO-263	KTT	3	45	Pb-Free (RoHS Exempt)	CU SN	Level-3-245C-168 HR	0 to 125	LM2940CS -15 P+	<a href="#">Samples</a>
LM2940CS-5.0	NRND	DDPAK/ TO-263	KTT	3	45	TBD	Call TI	Call TI	0 to 125	LM2940CS -5.0 P+	
LM2940CS-5.0/NOPB	ACTIVE	DDPAK/ TO-263	KTT	3	45	Pb-Free (RoHS Exempt)	CU SN	Level-3-245C-168 HR	0 to 125	LM2940CS -5.0 P+	<a href="#">Samples</a>
LM2940CS-9.0/NOPB	ACTIVE	DDPAK/ TO-263	KTT	3	45	Pb-Free (RoHS Exempt)	CU SN	Level-3-245C-168 HR	0 to 125	LM2940CS -9.0 P+	<a href="#">Samples</a>
LM2940CSX-12	NRND	DDPAK/ TO-263	KTT	3	500	TBD	Call TI	Call TI	0 to 125	LM2940CS -12 P+	
LM2940CSX-12/NOPB	ACTIVE	DDPAK/ TO-263	KTT	3	500	Pb-Free (RoHS Exempt)	CU SN	Level-3-245C-168 HR	0 to 125	LM2940CS -12 P+	<a href="#">Samples</a>
LM2940CSX-15/NOPB	ACTIVE	DDPAK/ TO-263	KTT	3	500	Pb-Free (RoHS Exempt)	CU SN	Level-3-245C-168 HR	0 to 125	LM2940CS -15 P+	<a href="#">Samples</a>
LM2940CSX-5.0	NRND	DDPAK/ TO-263	KTT	3		TBD	Call TI	Call TI	0 to 125	LM2940CS -5.0 P+	
LM2940CSX-5.0/NOPB	ACTIVE	DDPAK/ TO-263	KTT	3	500	Pb-Free (RoHS Exempt)	CU SN	Level-3-245C-168 HR	0 to 125	LM2940CS -5.0 P+	<a href="#">Samples</a>
LM2940CSX-9.0/NOPB	ACTIVE	DDPAK/ TO-263	KTT	3	500	Pb-Free (RoHS Exempt)	CU SN	Level-3-245C-168 HR	0 to 125	LM2940CS -9.0 P+	<a href="#">Samples</a>
LM2940CT-12	NRND	TO-220	NDE	3	45	TBD	Call TI	Call TI	0 to 125	LM2940CT -12 P+	
LM2940CT-12/NOPB	ACTIVE	TO-220	NDE	3	45	Green (RoHS & no Sb/Br)	CU SN	Level-1-NA-UNLIM	0 to 125	LM2940CT -12 P+	<a href="#">Samples</a>
LM2940CT-15	NRND	TO-220	NDE	3	45	TBD	Call TI	Call TI	0 to 125	LM2940CT -15 P+	
LM2940CT-15/NOPB	ACTIVE	TO-220	NDE	3	45	Green (RoHS & no Sb/Br)	CU SN	Level-1-NA-UNLIM	0 to 125	LM2940CT -15 P+	<a href="#">Samples</a>

Orderable Device	Status (1)	Package Type	Package Drawing	Pins	Package Qty	Eco Plan (2)	Lead/Ball Finish (6)	MSL Peak Temp (3)	Op Temp (°C)	Device Marking (4/5)	Samples
LM2940CT-5.0	NRND	TO-220	NDE	3	45	TBD	Call TI	Call TI	0 to 125	LM2940CT -5.0 P+	
LM2940CT-5.0/LF01	ACTIVE	TO-220	NDG	3	45	Pb-Free (RoHS Exempt)	CU SN	Level-3-245C-168 HR		LM2940CT -5.0 P+	<a href="#">Samples</a>
LM2940CT-5.0/NOPB	ACTIVE	TO-220	NDE	3	45	Green (RoHS & no Sb/Br)	CU SN	Level-1-NA-UNLIM	0 to 125	LM2940CT -5.0 P+	<a href="#">Samples</a>
LM2940CT-9.0/NOPB	ACTIVE	TO-220	NDE	3	45	Green (RoHS & no Sb/Br)	CU SN	Level-1-NA-UNLIM	0 to 125	LM2940CT -9.0 P+	<a href="#">Samples</a>
LM2940IMP-10/NOPB	ACTIVE	SOT-223	DCY	4	1000	Green (RoHS & no Sb/Br)	CU SN	Level-1-260C-UNLIM	-40 to 85	L55B	<a href="#">Samples</a>
LM2940IMP-12/NOPB	ACTIVE	SOT-223	DCY	4	1000	Green (RoHS & no Sb/Br)	CU SN	Level-1-260C-UNLIM	-40 to 85	L56B	<a href="#">Samples</a>
LM2940IMP-15	NRND	SOT-223	DCY	4	1000	TBD	Call TI	Call TI	-40 to 85	L70B	
LM2940IMP-15/NOPB	ACTIVE	SOT-223	DCY	4	1000	Green (RoHS & no Sb/Br)	CU SN	Level-1-260C-UNLIM	-40 to 85	L70B	<a href="#">Samples</a>
LM2940IMP-5.0	NRND	SOT-223	DCY	4	1000	TBD	Call TI	Call TI	-40 to 85	L53B	
LM2940IMP-5.0/NOPB	ACTIVE	SOT-223	DCY	4	1000	Green (RoHS & no Sb/Br)	CU SN	Level-1-260C-UNLIM	-40 to 85	L53B	<a href="#">Samples</a>
LM2940IMP-9.0/NOPB	ACTIVE	SOT-223	DCY	4	1000	Green (RoHS & no Sb/Br)	CU SN	Level-1-260C-UNLIM	-40 to 85	L0EB	<a href="#">Samples</a>
LM2940IMPX-10/NOPB	ACTIVE	SOT-223	DCY	4	2000	Green (RoHS & no Sb/Br)	CU SN	Level-1-260C-UNLIM	-40 to 85	L55B	<a href="#">Samples</a>
LM2940IMPX-12/NOPB	ACTIVE	SOT-223	DCY	4	2000	Green (RoHS & no Sb/Br)	CU SN	Level-1-260C-UNLIM	-40 to 85	L56B	<a href="#">Samples</a>
LM2940IMPX-5.0/NOPB	ACTIVE	SOT-223	DCY	4	2000	Green (RoHS & no Sb/Br)	CU SN	Level-1-260C-UNLIM	-40 to 85	L53B	<a href="#">Samples</a>
LM2940IMPX-8.0/NOPB	ACTIVE	SOT-223	DCY	4	2000	Green (RoHS & no Sb/Br)	CU SN	Level-1-260C-UNLIM	-40 to 85	L54B	<a href="#">Samples</a>
LM2940LD-12	NRND	WSON	NGN	8	1000	TBD	Call TI	Call TI	-40 to 125	L00018B	
LM2940LD-12/NOPB	ACTIVE	WSON	NGN	8	1000	Green (RoHS & no Sb/Br)	CU SN	Level-3-260C-168 HR	-40 to 125	L00018B	<a href="#">Samples</a>
LM2940LD-5.0/NOPB	ACTIVE	WSON	NGN	8	1000	Green (RoHS & no Sb/Br)	CU SN	Level-3-260C-168 HR	-40 to 125	L00014B	<a href="#">Samples</a>
LM2940S-10	NRND	DDPAK/ TO-263	KTT	3	45	TBD	Call TI	Call TI	-40 to 125	LM2940S -10 P+	

Orderable Device	Status (1)	Package Type	Package Drawing	Pins	Package Qty	Eco Plan (2)	Lead/Ball Finish (6)	MSL Peak Temp (3)	Op Temp (°C)	Device Marking (4/5)	Samples
LM2940S-10/NOPB	ACTIVE	DDPAK/ TO-263	KTT	3	45	Pb-Free (RoHS Exempt)	CU SN	Level-3-245C-168 HR	-40 to 125	LM2940S -10 P+	<a href="#">Samples</a>
LM2940S-12	NRND	DDPAK/ TO-263	KTT	3	45	TBD	Call TI	Call TI	-40 to 125	LM2940S -12 P+	
LM2940S-12/NOPB	ACTIVE	DDPAK/ TO-263	KTT	3	45	Pb-Free (RoHS Exempt)	CU SN	Level-3-245C-168 HR	-40 to 125	LM2940S -12 P+	<a href="#">Samples</a>
LM2940S-5.0	NRND	DDPAK/ TO-263	KTT	3	45	TBD	Call TI	Call TI	-40 to 125	LM2940S -5.0 P+	
LM2940S-5.0/NOPB	ACTIVE	DDPAK/ TO-263	KTT	3	45	Pb-Free (RoHS Exempt)	CU SN	Level-3-245C-168 HR	-40 to 125	LM2940S -5.0 P+	<a href="#">Samples</a>
LM2940S-8.0/NOPB	ACTIVE	DDPAK/ TO-263	KTT	3	45	Pb-Free (RoHS Exempt)	CU SN	Level-3-245C-168 HR	-40 to 125	LM2940S -8.0 P+	<a href="#">Samples</a>
LM2940S-9.0/NOPB	ACTIVE	DDPAK/ TO-263	KTT	3	45	Pb-Free (RoHS Exempt)	CU SN	Level-3-245C-168 HR	-40 to 125	LM2940S -9.0 P+	<a href="#">Samples</a>
LM2940SX-10	NRND	DDPAK/ TO-263	KTT	3	500	TBD	Call TI	Call TI	-40 to 125	LM2940S -10 P+	
LM2940SX-10/NOPB	ACTIVE	DDPAK/ TO-263	KTT	3	500	Pb-Free (RoHS Exempt)	CU SN	Level-3-245C-168 HR	-40 to 125	LM2940S -10 P+	<a href="#">Samples</a>
LM2940SX-12	NRND	DDPAK/ TO-263	KTT	3	500	TBD	Call TI	Call TI	-40 to 125	LM2940S -12 P+	
LM2940SX-12/NOPB	ACTIVE	DDPAK/ TO-263	KTT	3	500	Pb-Free (RoHS Exempt)	CU SN	Level-3-245C-168 HR	-40 to 125	LM2940S -12 P+	<a href="#">Samples</a>
LM2940SX-5.0	NRND	DDPAK/ TO-263	KTT	3	500	TBD	Call TI	Call TI	-40 to 125	LM2940S -5.0 P+	
LM2940SX-5.0/NOPB	ACTIVE	DDPAK/ TO-263	KTT	3	500	Pb-Free (RoHS Exempt)	CU SN	Level-3-245C-168 HR	-40 to 125	LM2940S -5.0 P+	<a href="#">Samples</a>
LM2940SX-8.0/NOPB	ACTIVE	DDPAK/ TO-263	KTT	3	500	Pb-Free (RoHS Exempt)	CU SN	Level-3-245C-168 HR	-40 to 125	LM2940S -8.0 P+	<a href="#">Samples</a>
LM2940SX-9.0/NOPB	ACTIVE	DDPAK/ TO-263	KTT	3	500	Pb-Free (RoHS Exempt)	CU SN	Level-3-245C-168 HR	-40 to 125	LM2940S -9.0 P+	<a href="#">Samples</a>
LM2940T-10.0	NRND	TO-220	NDE	3	45	TBD	Call TI	Call TI	-40 to 125	LM2940T 10.0 P+	
LM2940T-10.0/NOPB	ACTIVE	TO-220	NDE	3	45	Green (RoHS & no Sb/Br)	CU SN	Level-1-NA-UNLIM	-40 to 125	LM2940T 10.0 P+	<a href="#">Samples</a>
LM2940T-12.0	NRND	TO-220	NDE	3	45	TBD	Call TI	Call TI	-40 to 125	LM2940T 12.0 P+	

Orderable Device	Status (1)	Package Type	Package Drawing	Pins	Package Qty	Eco Plan (2)	Lead/Ball Finish (6)	MSL Peak Temp (3)	Op Temp (°C)	Device Marking (4/5)	Samples
LM2940T-12.0/NOPB	ACTIVE	TO-220	NDE	3	45	Green (RoHS & no Sb/Br)	CU SN	Level-1-NA-UNLIM	-40 to 125	LM2940T 12.0 P+	<a href="#">Samples</a>
LM2940T-5.0	NRND	TO-220	NDE	3	45	TBD	Call TI	Call TI	-40 to 125	LM2940T -5.0 P+	
LM2940T-5.0/LF08	ACTIVE	TO-220	NEB	3	45	Green (RoHS & no Sb/Br)	CU SN	Level-3-245C-168 HR		LM2940T -5.0 P+	<a href="#">Samples</a>
LM2940T-5.0/NOPB	ACTIVE	TO-220	NDE	3	45	Green (RoHS & no Sb/Br)	CU SN	Level-1-NA-UNLIM	-40 to 125	LM2940T -5.0 P+	<a href="#">Samples</a>
LM2940T-8.0	NRND	TO-220	NDE	3	45	TBD	Call TI	Call TI	-40 to 125	LM2940T -8.0 P+	
LM2940T-8.0/NOPB	ACTIVE	TO-220	NDE	3	45	Green (RoHS & no Sb/Br)	CU SN	Level-1-NA-UNLIM	-40 to 125	LM2940T -8.0 P+	<a href="#">Samples</a>
LM2940T-9.0	NRND	TO-220	NDE	3	45	TBD	Call TI	Call TI	-40 to 125	LM2940T -9.0 P+	
LM2940T-9.0/NOPB	ACTIVE	TO-220	NDE	3	45	Green (RoHS & no Sb/Br)	CU SN	Level-1-NA-UNLIM	-40 to 125	LM2940T -9.0 P+	<a href="#">Samples</a>

(1) The marketing status values are defined as follows:

**ACTIVE:** Product device recommended for new designs.

**LIFEBUY:** TI has announced that the device will be discontinued, and a lifetime-buy period is in effect.

**NRND:** Not recommended for new designs. Device is in production to support existing customers, but TI does not recommend using this part in a new design.

**PREVIEW:** Device has been announced but is not in production. Samples may or may not be available.

**OBSOLETE:** TI has discontinued the production of the device.

(2) **RoHS:** TI defines "RoHS" to mean semiconductor products that are compliant with the current EU RoHS requirements for all 10 RoHS substances, including the requirement that RoHS substance do not exceed 0.1% by weight in homogeneous materials. Where designed to be soldered at high temperatures, "RoHS" products are suitable for use in specified lead-free processes. TI may reference these types of products as "Pb-Free".

**RoHS Exempt:** TI defines "RoHS Exempt" to mean products that contain lead but are compliant with EU RoHS pursuant to a specific EU RoHS exemption.

**Green:** TI defines "Green" to mean the content of Chlorine (Cl) and Bromine (Br) based flame retardants meet JS709B low halogen requirements of <=1000ppm threshold. Antimony trioxide based flame retardants must also meet the <=1000ppm threshold requirement.

(3) MSL, Peak Temp. - The Moisture Sensitivity Level rating according to the JEDEC industry standard classifications, and peak solder temperature.

(4) There may be additional marking, which relates to the logo, the lot trace code information, or the environmental category on the device.

(5) Multiple Device Markings will be inside parentheses. Only one Device Marking contained in parentheses and separated by a "~" will appear on a device. If a line is indented then it is a continuation of the previous line and the two combined represent the entire Device Marking for that device.



<sup>(6)</sup> Lead/Ball Finish - Orderable Devices may have multiple material finish options. Finish options are separated by a vertical ruled line. Lead/Ball Finish values may wrap to two lines if the finish value exceeds the maximum column width.

**Important Information and Disclaimer:** The information provided on this page represents TI's knowledge and belief as of the date that it is provided. TI bases its knowledge and belief on information provided by third parties, and makes no representation or warranty as to the accuracy of such information. Efforts are underway to better integrate information from third parties. TI has taken and continues to take reasonable steps to provide representative and accurate information but may not have conducted destructive testing or chemical analysis on incoming materials and chemicals. TI and TI suppliers consider certain information to be proprietary, and thus CAS numbers and other limited information may not be available for release.

In no event shall TI's liability arising out of such information exceed the total purchase price of the TI part(s) at issue in this document sold by TI to Customer on an annual basis.

**TAPE AND REEL INFORMATION**



**QUADRANT ASSIGNMENTS FOR PIN 1 ORIENTATION IN TAPE**

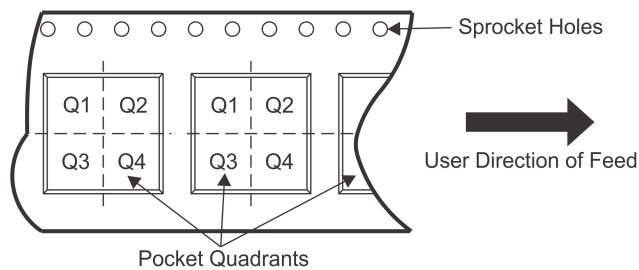

\*All dimensions are nominal

Device	Package Type	Package Drawing	Pins	SPQ	Reel Diameter (mm)	Reel Width W1 (mm)	A0 (mm)	B0 (mm)	K0 (mm)	P1 (mm)	W (mm)	Pin1 Quadrant
LM2940CSX-12	DDPAK/TO-263	KTT	3	500	330.0	24.4	10.75	14.85	5.0	16.0	24.0	Q2
LM2940CSX-12/NOPB	DDPAK/TO-263	KTT	3	500	330.0	24.4	10.75	14.85	5.0	16.0	24.0	Q2
LM2940CSX-15/NOPB	DDPAK/TO-263	KTT	3	500	330.0	24.4	10.75	14.85	5.0	16.0	24.0	Q2
LM2940CSX-5.0/NOPB	DDPAK/TO-263	KTT	3	500	330.0	24.4	10.75	14.85	5.0	16.0	24.0	Q2
LM2940CSX-9.0/NOPB	DDPAK/TO-263	KTT	3	500	330.0	24.4	10.75	14.85	5.0	16.0	24.0	Q2
LM2940IMP-10/NOPB	SOT-223	DCY	4	1000	330.0	16.4	7.0	7.5	2.2	12.0	16.0	Q3
LM2940IMP-12/NOPB	SOT-223	DCY	4	1000	330.0	16.4	7.0	7.5	2.2	12.0	16.0	Q3
LM2940IMP-15	SOT-223	DCY	4	1000	330.0	16.4	7.0	7.5	2.2	12.0	16.0	Q3
LM2940IMP-15/NOPB	SOT-223	DCY	4	1000	330.0	16.4	7.0	7.5	2.2	12.0	16.0	Q3
LM2940IMP-5.0	SOT-223	DCY	4	1000	330.0	16.4	7.0	7.5	2.2	12.0	16.0	Q3
LM2940IMP-5.0/NOPB	SOT-223	DCY	4	1000	330.0	16.4	7.0	7.5	2.2	12.0	16.0	Q3
LM2940IMP-9.0/NOPB	SOT-223	DCY	4	1000	330.0	16.4	7.0	7.5	2.2	12.0	16.0	Q3
LM2940IMPX-10/NOPB	SOT-223	DCY	4	2000	330.0	16.4	7.0	7.5	2.2	12.0	16.0	Q3
LM2940IMPX-12/NOPB	SOT-223	DCY	4	2000	330.0	16.4	7.0	7.5	2.2	12.0	16.0	Q3

Device	Package Type	Package Drawing	Pins	SPQ	Reel Diameter (mm)	Reel Width W1 (mm)	A0 (mm)	B0 (mm)	K0 (mm)	P1 (mm)	W (mm)	Pin1 Quadrant
LM2940IMPX-5.0/NOPB	SOT-223	DCY	4	2000	330.0	16.4	7.0	7.5	2.2	12.0	16.0	Q3
LM2940IMPX-8.0/NOPB	SOT-223	DCY	4	2000	330.0	16.4	7.0	7.5	2.2	12.0	16.0	Q3
LM2940LD-12	WSON	NGN	8	1000	178.0	12.4	4.3	4.3	1.3	8.0	12.0	Q1
LM2940LD-12/NOPB	WSON	NGN	8	1000	178.0	12.4	4.3	4.3	1.3	8.0	12.0	Q1
LM2940LD-5.0/NOPB	WSON	NGN	8	1000	178.0	12.4	4.3	4.3	1.3	8.0	12.0	Q1
LM2940SX-10	DDPAK/ TO-263	KTT	3	500	330.0	24.4	10.75	14.85	5.0	16.0	24.0	Q2
LM2940SX-10/NOPB	DDPAK/ TO-263	KTT	3	500	330.0	24.4	10.75	14.85	5.0	16.0	24.0	Q2
LM2940SX-12	DDPAK/ TO-263	KTT	3	500	330.0	24.4	10.75	14.85	5.0	16.0	24.0	Q2
LM2940SX-12/NOPB	DDPAK/ TO-263	KTT	3	500	330.0	24.4	10.75	14.85	5.0	16.0	24.0	Q2
LM2940SX-5.0	DDPAK/ TO-263	KTT	3	500	330.0	24.4	10.75	14.85	5.0	16.0	24.0	Q2
LM2940SX-5.0/NOPB	DDPAK/ TO-263	KTT	3	500	330.0	24.4	10.75	14.85	5.0	16.0	24.0	Q2
LM2940SX-8.0/NOPB	DDPAK/ TO-263	KTT	3	500	330.0	24.4	10.75	14.85	5.0	16.0	24.0	Q2
LM2940SX-9.0/NOPB	DDPAK/ TO-263	KTT	3	500	330.0	24.4	10.75	14.85	5.0	16.0	24.0	Q2

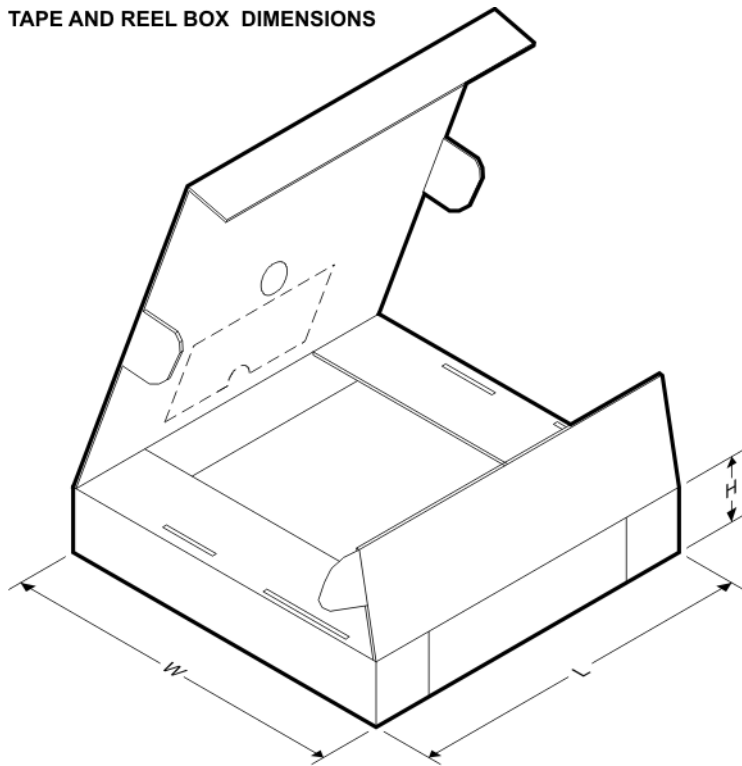
**TAPE AND REEL BOX DIMENSIONS**

\*All dimensions are nominal

Device	Package Type	Package Drawing	Pins	SPQ	Length (mm)	Width (mm)	Height (mm)
LM2940CSX-12	DDPAK/TO-263	KTT	3	500	367.0	367.0	45.0
LM2940CSX-12/NOPB	DDPAK/TO-263	KTT	3	500	367.0	367.0	45.0
LM2940CSX-15/NOPB	DDPAK/TO-263	KTT	3	500	367.0	367.0	45.0
LM2940CSX-5.0/NOPB	DDPAK/TO-263	KTT	3	500	367.0	367.0	45.0
LM2940CSX-9.0/NOPB	DDPAK/TO-263	KTT	3	500	367.0	367.0	45.0
LM2940IMP-10/NOPB	SOT-223	DCY	4	1000	367.0	367.0	35.0
LM2940IMP-12/NOPB	SOT-223	DCY	4	1000	367.0	367.0	35.0
LM2940IMP-15	SOT-223	DCY	4	1000	367.0	367.0	35.0
LM2940IMP-15/NOPB	SOT-223	DCY	4	1000	367.0	367.0	35.0
LM2940IMP-5.0	SOT-223	DCY	4	1000	367.0	367.0	35.0
LM2940IMP-5.0/NOPB	SOT-223	DCY	4	1000	367.0	367.0	35.0
LM2940IMP-9.0/NOPB	SOT-223	DCY	4	1000	367.0	367.0	35.0
LM2940IMPX-10/NOPB	SOT-223	DCY	4	2000	367.0	367.0	35.0
LM2940IMPX-12/NOPB	SOT-223	DCY	4	2000	367.0	367.0	35.0
LM2940IMPX-5.0/NOPB	SOT-223	DCY	4	2000	367.0	367.0	35.0
LM2940IMPX-8.0/NOPB	SOT-223	DCY	4	2000	367.0	367.0	35.0
LM2940LD-12	WSON	NGN	8	1000	210.0	185.0	35.0
LM2940LD-12/NOPB	WSON	NGN	8	1000	210.0	185.0	35.0
LM2940LD-5.0/NOPB	WSON	NGN	8	1000	210.0	185.0	35.0
LM2940SX-10	DDPAK/TO-263	KTT	3	500	367.0	367.0	45.0
LM2940SX-10/NOPB	DDPAK/TO-263	KTT	3	500	367.0	367.0	45.0
LM2940SX-12	DDPAK/TO-263	KTT	3	500	367.0	367.0	45.0
LM2940SX-12/NOPB	DDPAK/TO-263	KTT	3	500	367.0	367.0	45.0
LM2940SX-5.0	DDPAK/TO-263	KTT	3	500	367.0	367.0	45.0
LM2940SX-5.0/NOPB	DDPAK/TO-263	KTT	3	500	367.0	367.0	45.0
LM2940SX-8.0/NOPB	DDPAK/TO-263	KTT	3	500	367.0	367.0	45.0
LM2940SX-9.0/NOPB	DDPAK/TO-263	KTT	3	500	367.0	367.0	45.0

NDE0003B



KTT0003B



TS3B (Rev F)

DCY (R-PDSO-G4)

PLASTIC SMALL-OUTLINE



- NOTES: A. All linear dimensions are in millimeters (inches).  
 B. This drawing is subject to change without notice.  
 C. Body dimensions do not include mold flash or protrusion.  
 D. Falls within JEDEC TO-261 Variation AA.

DCY (R-PDSO-G4)

PLASTIC SMALL OUTLINE



- NOTES:
- A. All linear dimensions are in millimeters.
  - B. This drawing is subject to change without notice.
  - C. Publication IPC-7351 is recommended for alternate designs.
  - D. Laser cutting apertures with trapezoidal walls and also rounding corners will offer better paste release. Customers should contact their board assembly site for stencil recommendations. Refer to IPC 7525 for stencil design considerations.



NDG0003F

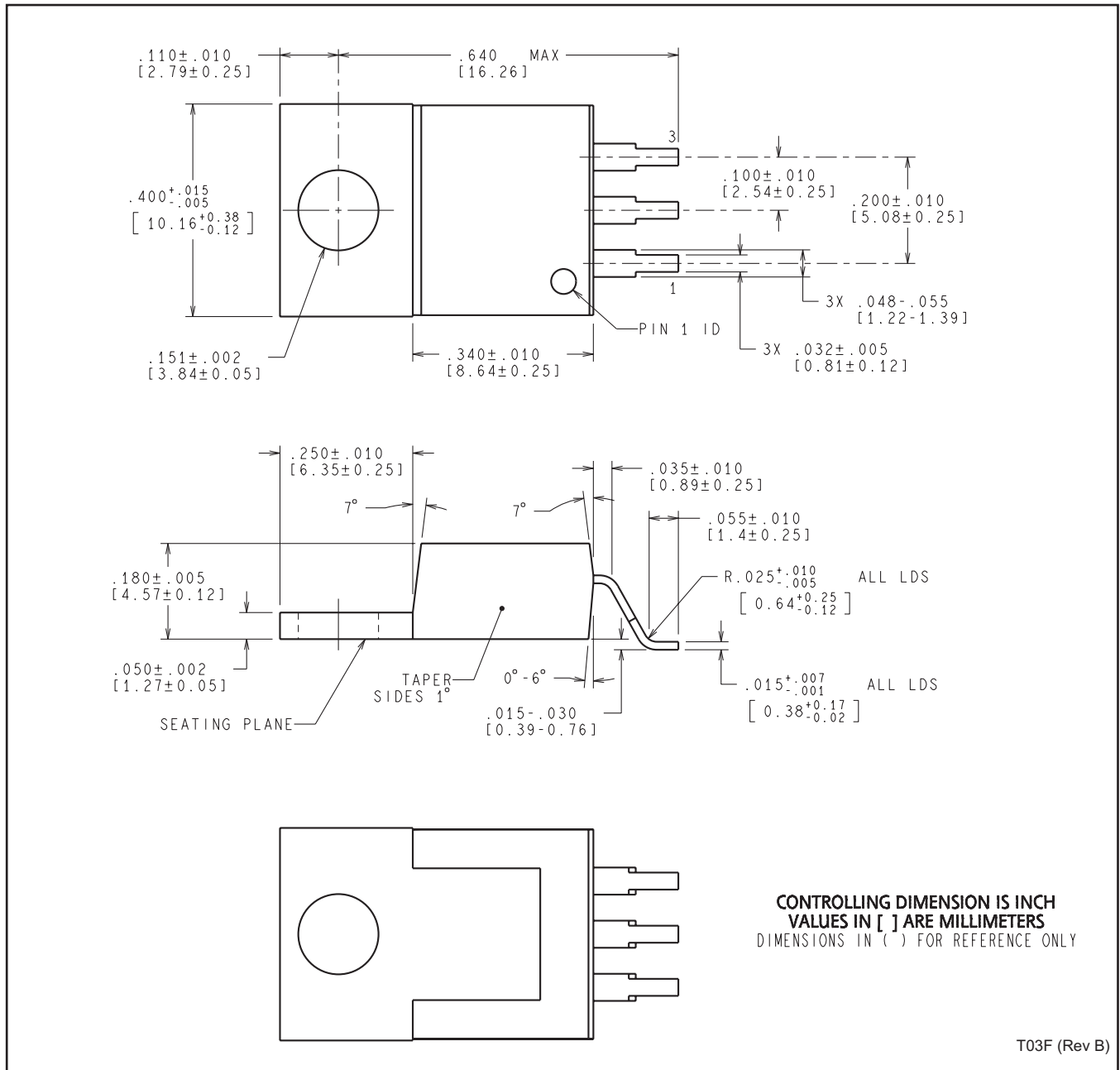

NGN0008A

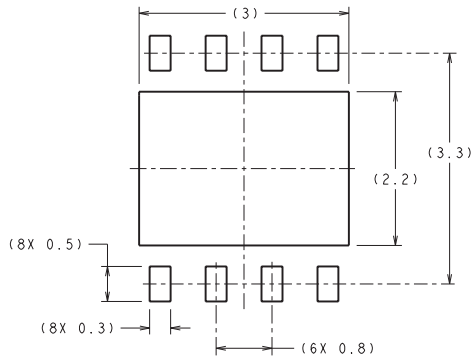

**RECOMMENDED LAND PATTERN**  
1:1 RATION WITH PKG SOLDER PADS

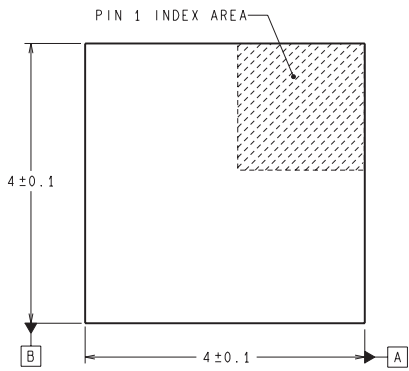

**DIMENSIONS ARE IN MILLIMETERS**  
DIMENSIONS IN ( ) FOR REFERENCE ONLY

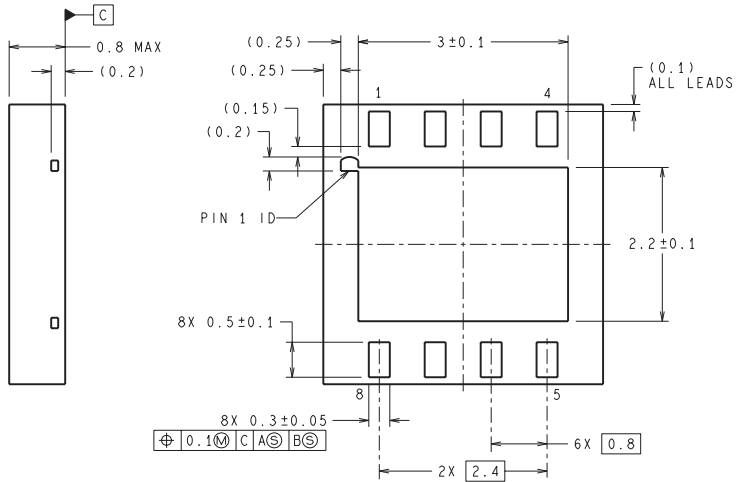

LDC08A (Rev B)

## IMPORTANT NOTICE AND DISCLAIMER

TI PROVIDES TECHNICAL AND RELIABILITY DATA (INCLUDING DATASHEETS), DESIGN RESOURCES (INCLUDING REFERENCE DESIGNS), APPLICATION OR OTHER DESIGN ADVICE, WEB TOOLS, SAFETY INFORMATION, AND OTHER RESOURCES "AS IS" AND WITH ALL FAULTS, AND DISCLAIMS ALL WARRANTIES, EXPRESS AND IMPLIED, INCLUDING WITHOUT LIMITATION ANY IMPLIED WARRANTIES OF MERCHANTABILITY, FITNESS FOR A PARTICULAR PURPOSE OR NON-INFRINGEMENT OF THIRD PARTY INTELLECTUAL PROPERTY RIGHTS.

These resources are intended for skilled developers designing with TI products. You are solely responsible for (1) selecting the appropriate TI products for your application, (2) designing, validating and testing your application, and (3) ensuring your application meets applicable standards, and any other safety, security, or other requirements. These resources are subject to change without notice. TI grants you permission to use these resources only for development of an application that uses the TI products described in the resource. Other reproduction and display of these resources is prohibited. No license is granted to any other TI intellectual property right or to any third party intellectual property right. TI disclaims responsibility for, and you will fully indemnify TI and its representatives against, any claims, damages, costs, losses, and liabilities arising out of your use of these resources.

TI's products are provided subject to TI's Terms of Sale ([www.ti.com/legal/termsofsale.html](http://www.ti.com/legal/termsofsale.html)) or other applicable terms available either on [ti.com](http://ti.com) or provided in conjunction with such TI products. TI's provision of these resources does not expand or otherwise alter TI's applicable warranties or warranty disclaimers for TI products.

Mailing Address: Texas Instruments, Post Office Box 655303, Dallas, Texas 75265  
Copyright © 2018, Texas Instruments Incorporated