



# EVERLIGHT ELECTRONICS CO.,LTD.

Device Number : CDLE-052-113 REV.: 1

2.0\*5.0mm Rectangle Type LED Lamps

PART NO. : 523ID

ECN: \_\_\_\_\_

Page: 1/4

## ■ Features :

- Choice of various viewing angles
- Available on tape and reel.
- Reliable and robust

## ■ Descriptions :

- The series is specially designed for applications requiring higher brightness
- The led lamps are available with different colors, intensities,

## ■ Applications :

- TV set
- Monitor
- Telephone
- Computer

## ■ Package Dimensions:

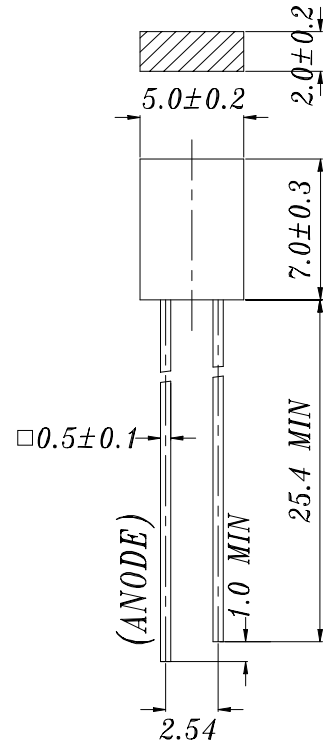

## ■ Notes :

1. All dimensions are in millimeters.
2. An epoxy meniscus may extend about 1.5mm(0.059") down to the lead.
3. Tolerances unless Dimension ±0.25mm.

PART NO.	Chip		Lens Color
	Material	Emitted Color	
523ID	GaAsP/GaP	Hi-Eff Red	Red Diffused

Office : 7C Building, Lian Hua Port Industrial District, Lian Hua Shan  
 Bonded Pricessing Zone Pan Yu, Guang Zhou, China  
 TEL. : (020)84860913,84860914  
 FAX : (020)84860600  
 http : //www.everlight.com





# EVERLIGHT ELECTRONICS CO.,LTD.

Device Number : CDLE-052-113 REV.: 1

2.0\*5.0mm Rectangle Type LED Lamps

PART NO. : 523ID

ECN : \_\_\_\_\_ Page: 3/4

## ■ Typical Electro-Optical Characteristic Curves:

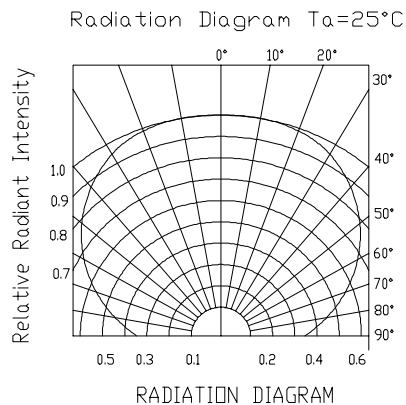
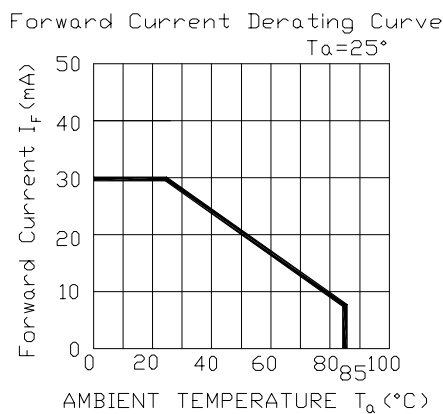
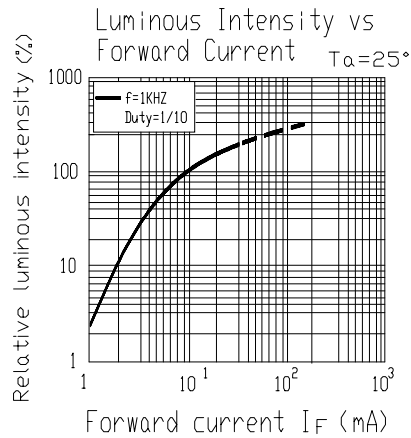
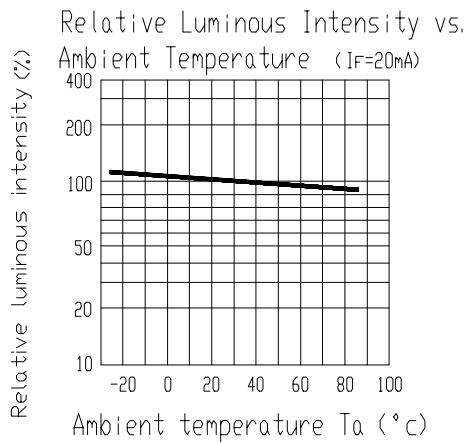
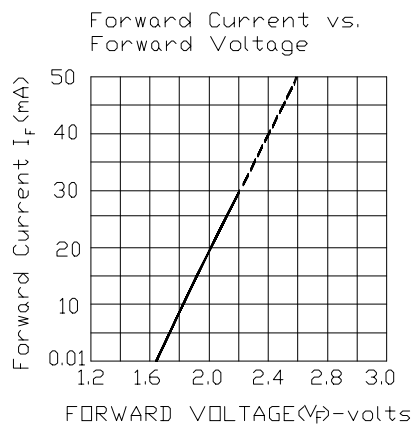
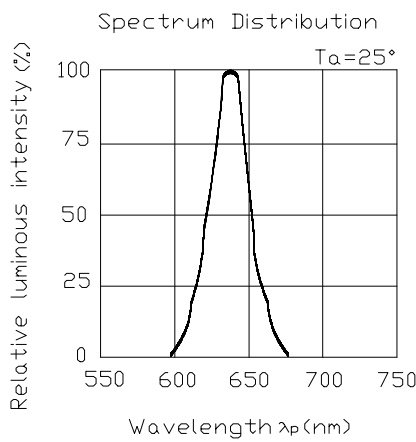



# EVERLIGHT ELECTRONICS CO.,LTD.

Device Number : CDLE-052-113 REV.: 1

2.0\*5.0mm Rectangle Type LED Lamps

PART NO. : 523ID ECN :  Page: 4/4

## ■ Reliability test items and conditions:

NO	Item	Test Conditions	Test Hours/Cycle		Ac/Re
1	Solder Heat	TEMP : 260°C ± 5 °C	5 SEC	76 PCS	0/1
2	Temperature Cycle	H : +85°C 30min ∫ 5 min L : -55°C 30min	50 CYCLES	76 PCS	0/1
3	Thermal Shock	H : +100°C 5min ∫ 10 sec L : -10°C 5min	50 CYCLES	76 PCS	0/1
4	High Temperature Storage	TEMP : 100°C	1000 HRS	76 PCS	0/1
5	Low Temperature Storage	TEMP : -55°C	1000 HRS	76 PCS	0/1
6	DC Operating Life	TEMP : 25°C IF = 20mA	1000 HRS	76 PCS	0/1
7	High Temperature / High Humidity	85°C / 85% RH	1000 HRS	76 PCS	0/1