

TELUX™ LED

Description

The TELUX™ series is a clear, non diffused LED for high end applications where supreme luminous flux is required.

It is designed in an industry standard 7.62 mm square package utilizing highly developed (AS) AllnGaP and InGaN technologies.

The supreme heat dissipation of TELUX™ allows applications at high ambient temperatures.

All packing units are binned for luminous flux and color to achieve best homogenous light appearance in application.

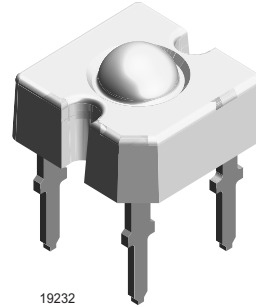

Features

- Utilizing (AS) AllnGaP and InGaN technologies
- High luminous flux
- Supreme heat dissipation: R_{thJP} is 90 K/W
- High operating temperature:
 $T_{amb} = - 40$ to $+ 110$ °C
- Type TLWR meets SAE and ECE color requirements
- Packed in tubes for automatic insertion
- Luminous flux and color categorized for each tube
- Small mechanical tolerances allow precise usage of external reflectors or lightguides
- TLWR and TLWY types additionally forward voltage categorized
- ESD-withstand voltage:
> 2 kV acc. to MIL STD 883 D, Method 3015.7 for AllnGaP, > 1 kV for InGaN
- Lead-free device

Applications

- Exterior lighting
- Dashboard illumination
- Tail-, Stop - and Turn Signals of motor vehicles
- Replaces incandescent lamps
- Traffic signals and signs

Parts Table

Part	Color, Luminous Intensity	Angle of Half Intensity ($\pm\phi$)	Technology
TLWR7600	Red, $\phi_V = (1500$ to $3000)$ mlm	30 °	AllnGaP on GaAs
TLWY7600	Yellow, $\phi_V = (1000$ to $2400)$ mlm	30 °	AllnGaP on GaAs
TLWO7600	Soft orange, $\phi_V = (1500$ to $3000)$ mlm	30 °	AllnGaP on GaAs
TLWTG7600	True green, $\phi_V = (630$ to $1800)$ mlm	30 °	InGaN on SiC
TLWBG7600	Blue green, $\phi_V = (400$ to $1250)$ mlm	30 °	InGaN on SiC
TLWB7600	Blue, $\phi_V = (200$ to $630)$ mlm	30 °	InGaN on SiC
TLWW7600	White, $\phi_V = (200$ to $630)$ mlm	30 °	InGaN / TAG on SiC

Absolute Maximum Ratings

$T_{amb} = 25\text{ }^{\circ}\text{C}$, unless otherwise specified

TLWR7600, TLWY7600, TLWO7600

Parameter	Test condition	Symbol	Value	Unit
Reverse voltage	$I_R = 10\text{ }\mu\text{A}$	V_R	10	V
DC Forward current	$T_{amb} \leq 85\text{ }^{\circ}\text{C}$	I_F	70	mA
Surge forward current	$t_p \leq 10\text{ }\mu\text{s}$	I_{FSM}	1	A
Power dissipation	$T_{amb} \leq 85\text{ }^{\circ}\text{C}$	P_V	187	mW
Junction temperature		T_j	125	$^{\circ}\text{C}$
Operating temperature range		T_{amb}	- 40 to + 110	$^{\circ}\text{C}$
Storage temperature range		T_{stg}	- 55 to + 110	$^{\circ}\text{C}$
Soldering temperature	$t \leq 5\text{ s}$, 1.5 mm from body preheat temperature 100 $^{\circ}\text{C}$ / 30 sec.	T_{sd}	260	$^{\circ}\text{C}$
Thermal resistance junction/ ambient	with cathode heatsink of 70 mm ²	R_{thJA}	200	K/W
Thermal resistance junction/pin		R_{thJP}	90	K/W

TLWTG7600, TLWBG7600, TLWB7600, TLWW7600

Parameter	Test condition	Part	Symbol	Value	Unit
Reverse voltage	$I_R = 10\text{ }\mu\text{A}$		V_R	5	V
DC Forward current	$T_{amb} \leq 50\text{ }^{\circ}\text{C}$		I_F	50	mA
Surge forward current	$t_p \leq 10\text{ }\mu\text{s}$		I_{FSM}	0.1	A
Power dissipation	$T_{amb} \leq 50\text{ }^{\circ}\text{C}$	TLWTG7600	P_V	230	mW
		TLWBG7600	P_V	230	mW
		TLWB7600	P_V	230	mW
		TLWW7600	P_V	255	mW
Junction temperature			T_j	100	$^{\circ}\text{C}$
Operating temperature range			T_{amb}	- 40 to + 100	$^{\circ}\text{C}$
Storage temperature range			T_{stg}	- 55 to + 100	$^{\circ}\text{C}$
Soldering temperature	$t \leq 5\text{ s}$, 1.5 mm from body preheat temperature 100 $^{\circ}\text{C}$ / 30 sec.		T_{sd}	260	$^{\circ}\text{C}$
Thermal resistance junction/ ambient	with cathode heatsink of 70 mm ²		R_{thJA}	200	K/W
Thermal resistance junction/pin			R_{thJP}	90	K/W

Optical and Electrical Characteristics

$T_{amb} = 25\text{ }^{\circ}\text{C}$, unless otherwise specified

Red

TLWR7600

Parameter	Test condition	Symbol	Min	Typ.	Max	Unit
Total flux	$I_F = 70\text{ mA}$, $R_{thJA} = 200\text{ }^{\circ}\text{K/W}$	ϕ_V	1500	2100	3000	mlm
Luminous intensity/Total flux	$I_F = 70\text{ mA}$, $R_{thJA} = 200\text{ }^{\circ}\text{K/W}$	I_V/ϕ_V		0.8		mcd/mlm
Dominant wavelength	$I_F = 70\text{ mA}$, $R_{thJA} = 200\text{ }^{\circ}\text{K/W}$	λ_d	611	618	634	nm
Peak wavelength	$I_F = 70\text{ mA}$, $R_{thJA} = 200\text{ }^{\circ}\text{K/W}$	λ_p		624		nm
Angle of half intensity	$I_F = 70\text{ mA}$, $R_{thJA} = 200\text{ }^{\circ}\text{K/W}$	ϕ		± 30		deg
Total included angle	90 % of Total Flux Captured	ϕ		75		deg
Forward voltage	$I_F = 70\text{ mA}$, $R_{thJA} = 200\text{ }^{\circ}\text{K/W}$	V_F	1.83	2.2	2.67	V



Parameter	Test condition	Symbol	Min	Typ.	Max	Unit
Reverse voltage	$I_R = 10 \mu\text{A}$	V_R	10	20		V
Junction capacitance	$V_R = 0, f = 1 \text{ MHz}$	C_j		17		pF
Temperature coefficient of λ_{dom}	$I_F = 50 \text{ mA}$	$TC\lambda_{\text{dom}}$		0.05		nm/K

Soft Orange

TLWO7600

Parameter	Test condition	Symbol	Min	Typ.	Max	Unit
Total flux	$I_F = 70 \text{ mA}, R_{\text{thJA}} = 200 \text{ }^\circ\text{K/W}$	ϕ_V	1500	2100	3000	mlm
Luminous intensity/Total flux	$I_F = 70 \text{ mA}, R_{\text{thJA}} = 200 \text{ }^\circ\text{K/W}$	I_V/ϕ_V		0.8		mcd/mlm
Dominant wavelength	$I_F = 70 \text{ mA}, R_{\text{thJA}} = 200 \text{ }^\circ\text{K/W}$	λ_d	598	605	611	nm
Peak wavelength	$I_F = 70 \text{ mA}, R_{\text{thJA}} = 200 \text{ }^\circ\text{K/W}$	λ_p		610		nm
Angle of half intensity	$I_F = 70 \text{ mA}, R_{\text{thJA}} = 200 \text{ }^\circ\text{K/W}$	φ		± 30		deg
Total included angle	90 % of Total Flux Captured	φ		75		deg
Forward voltage	$I_F = 70 \text{ mA}, R_{\text{thJA}} = 200 \text{ }^\circ\text{K/W}$	V_F	1.83	2.2	2.67	V
Reverse voltage	$I_R = 10 \mu\text{A}$	V_R	10	20		V
Junction capacitance	$V_R = 0, f = 1 \text{ MHz}$	C_j		17		pF
Temperature coefficient of λ_{dom}	$I_F = 50 \text{ mA}$	$TC\lambda_{\text{dom}}$		0.06		nm/K

Yellow

TLWY7600

Parameter	Test condition	Symbol	Min	Typ.	Max	Unit
Total flux	$I_F = 70 \text{ mA}, R_{\text{thJA}} = 200 \text{ }^\circ\text{K/W}$	ϕ_V	1000	1400	2400	mlm
Luminous intensity/Total flux	$I_F = 70 \text{ mA}, R_{\text{thJA}} = 200 \text{ }^\circ\text{K/W}$	I_V/ϕ_V		0.8		mcd/mlm
Dominant wavelength	$I_F = 70 \text{ mA}, R_{\text{thJA}} = 200 \text{ }^\circ\text{K/W}$	λ_d	585	592	597	nm
Peak wavelength	$I_F = 70 \text{ mA}, R_{\text{thJA}} = 200 \text{ }^\circ\text{K/W}$	λ_p		594		nm
Angle of half intensity	$I_F = 70 \text{ mA}, R_{\text{thJA}} = 200 \text{ }^\circ\text{K/W}$	φ		± 30		deg
Total included angle	90 % of Total Flux Captured	φ		75		deg
Forward voltage	$I_F = 70 \text{ mA}, R_{\text{thJA}} = 200 \text{ }^\circ\text{K/W}$	V_F	1.83	2.1	2.67	V
Reverse voltage	$I_R = 10 \mu\text{A}$	V_R	10	15		V
Junction capacitance	$V_R = 0, f = 1 \text{ MHz}$	C_j		32		pF
Temperature coefficient of λ_{dom}	$I_F = 50 \text{ mA}$	$TC\lambda_{\text{dom}}$		0.1		nm/K

True green

TLWTG7600

Parameter	Test condition	Symbol	Min	Typ.	Max	Unit
Total flux	$I_F = 50 \text{ mA}, R_{\text{thJA}} = 200 \text{ }^\circ\text{K/W}$	ϕ_V	630	900	1800	mlm
Luminous intensity/Total flux	$I_F = 50 \text{ mA}, R_{\text{thJA}} = 200 \text{ }^\circ\text{K/W}$	I_V/ϕ_V		0.8		mcd/mlm
Dominant wavelength	$I_F = 50 \text{ mA}, R_{\text{thJA}} = 200 \text{ }^\circ\text{K/W}$	λ_d	509	523	535	nm
Peak wavelength	$I_F = 50 \text{ mA}, R_{\text{thJA}} = 200 \text{ }^\circ\text{K/W}$	λ_p		518		nm
Angle of half intensity	$I_F = 50 \text{ mA}, R_{\text{thJA}} = 200 \text{ }^\circ\text{K/W}$	φ		± 30		deg
Total included angle	90 % of Total Flux Captured	φ		75		deg
Forward voltage	$I_F = 50 \text{ mA}, R_{\text{thJA}} = 200 \text{ }^\circ\text{K/W}$	V_F		4.2	4.7	V
Reverse voltage	$I_R = 10 \mu\text{A}$	V_R	5	10		V
Junction capacitance	$V_R = 0, f = 1 \text{ MHz}$	C_j		50		pF
Temperature coefficient of λ_{dom}	$I_F = 30 \text{ mA}$	$TC\lambda_{\text{dom}}$		0.02		nm/K

Blue green

TLWBG7600

Parameter	Test condition	Symbol	Min	Typ.	Max	Unit
Total flux	$I_F = 50 \text{ mA}$, $R_{thJA} = 200 \text{ }^\circ\text{K/W}$	ϕ_V	400	700	1250	mlm
Luminous intensity/Total flux	$I_F = 50 \text{ mA}$, $R_{thJA} = 200 \text{ }^\circ\text{K/W}$	I_V/ϕ_V		0.8		mcd/mlm
Dominant wavelength	$I_F = 50 \text{ mA}$, $R_{thJA} = 200 \text{ }^\circ\text{K/W}$	λ_d	492	505	510	nm
Peak wavelength	$I_F = 50 \text{ mA}$, $R_{thJA} = 200 \text{ }^\circ\text{K/W}$	λ_p		503		nm
Angle of half intensity	$I_F = 50 \text{ mA}$, $R_{thJA} = 200 \text{ }^\circ\text{K/W}$	ϕ		± 30		deg
Total included angle	90 % of Total Flux Captured	ϕ		75		deg
Forward voltage	$I_F = 50 \text{ mA}$, $R_{thJA} = 200 \text{ }^\circ\text{K/W}$	V_F		4.2	4.7	V
Reverse voltage	$I_R = 10 \text{ } \mu\text{A}$	V_R	5	10		V
Junction capacitance	$V_R = 0$, $f = 1 \text{ MHz}$	C_j		50		pF
Temperature coefficient of λ_{dom}	$I_F = 30 \text{ mA}$	$TC\lambda_{dom}$		0.02		nm/K

Blue

TLWB7600

Parameter	Test condition	Symbol	Min	Typ.	Max	Unit
Total flux	$I_F = 50 \text{ mA}$, $R_{thJA} = 200 \text{ }^\circ\text{K/W}$	ϕ_V	200	330	630	mlm
Luminous intensity/Total flux	$I_F = 50 \text{ mA}$, $R_{thJA} = 200 \text{ }^\circ\text{K/W}$	I_V/ϕ_V		0.8		mcd/mlm
Dominant wavelength	$I_F = 50 \text{ mA}$, $R_{thJA} = 200 \text{ }^\circ\text{K/W}$	λ_d	462	470	476	nm
Peak wavelength	$I_F = 50 \text{ mA}$, $R_{thJA} = 200 \text{ }^\circ\text{K/W}$	λ_p		460		nm
Angle of half intensity	$I_F = 50 \text{ mA}$, $R_{thJA} = 200 \text{ }^\circ\text{K/W}$	ϕ		± 30		deg
Total included angle	90 % of Total Flux Captured	ϕ		75		deg
Forward voltage	$I_F = 50 \text{ mA}$, $R_{thJA} = 200 \text{ }^\circ\text{K/W}$	V_F		4.3	4.7	V
Reverse voltage	$I_R = 10 \text{ } \mu\text{A}$	V_R	5	10		V
Junction capacitance	$V_R = 0$, $f = 1 \text{ MHz}$	C_j		50		pF
Temperature coefficient of λ_{dom}	$I_F = 30 \text{ mA}$	$TC\lambda_{dom}$		0.03		nm/K

White

TLWW7600

Parameter	Test condition	Symbol	Min	Typ.	Max	Unit
Total flux	$I_F = 50 \text{ mA}$, $R_{thJA} = 200 \text{ }^\circ\text{K/W}$	ϕ_V	400	650	1250	mlm
Luminous intensity/Total flux	$I_F = 50 \text{ mA}$, $R_{thJA} = 200 \text{ }^\circ\text{K/W}$	I_V/ϕ_V		0.8		mcd/mlm
Color temperature	$I_F = 50 \text{ mA}$, $R_{thJA} = 200 \text{ }^\circ\text{K/W}$	T_K		5500		K
Angle of half intensity	$I_F = 50 \text{ mA}$, $R_{thJA} = 200 \text{ }^\circ\text{K/W}$	ϕ		± 30		deg
Total included angle	90 % of Total Flux Captured	ϕ		75		deg
Forward voltage	$I_F = 50 \text{ mA}$, $R_{thJA} = 200 \text{ }^\circ\text{K/W}$	V_F		4.3	5.1	V
Reverse voltage	$I_R = 10 \text{ } \mu\text{A}$	V_R	5	10		V
Junction capacitance	$V_R = 0$, $f = 1 \text{ MHz}$	C_j		50		pF

Typical Characteristics ($T_{amb} = 25\text{ }^{\circ}\text{C}$ unless otherwise specified)

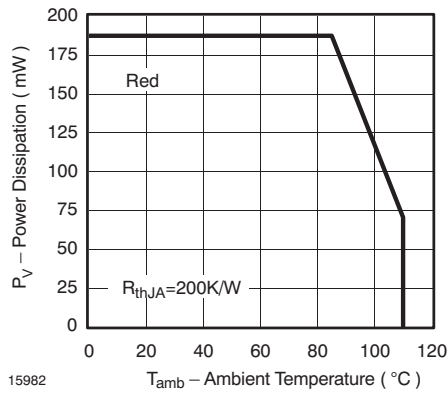

Figure 1. Power Dissipation vs. Ambient Temperature

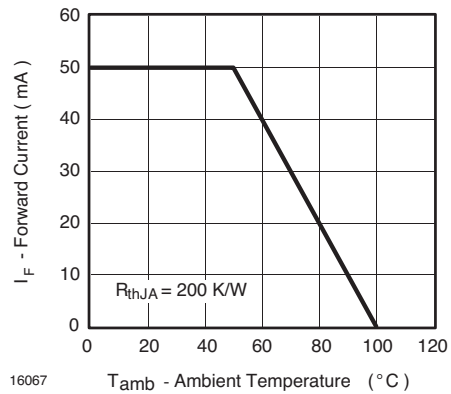

Figure 4. Forward Current vs. Ambient Temperature for InGaN

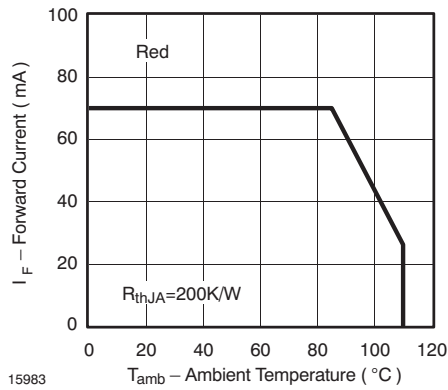

Figure 2. Forward Current vs. Ambient Temperature

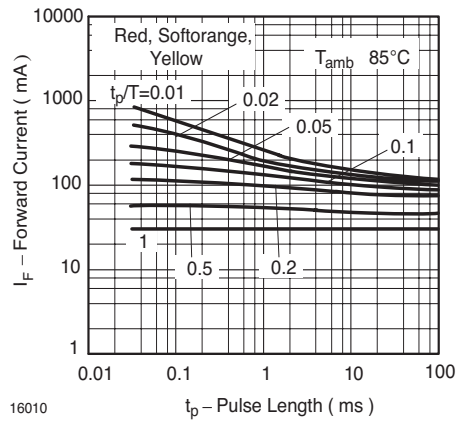

Figure 5. Forward Current vs. Pulse Length

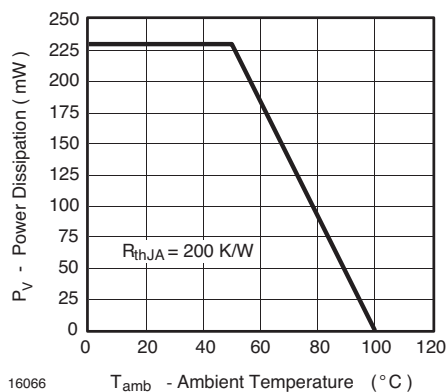

Figure 3. Power Dissipation vs. Ambient Temperature for InGaN

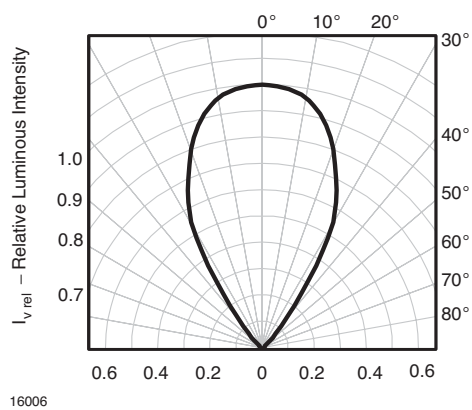

Figure 6. Rel. Luminous Intensity vs. Angular Displacement for 60° emission angle

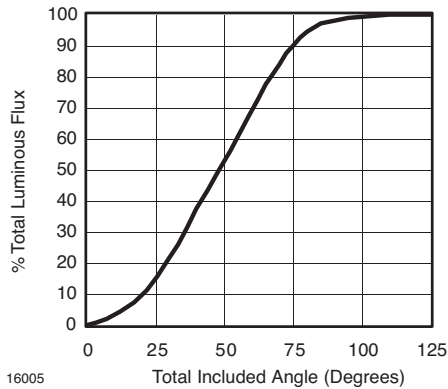

Figure 7. Percentage Total Luminous Flux vs. Total Included Angle for 60° emission angle

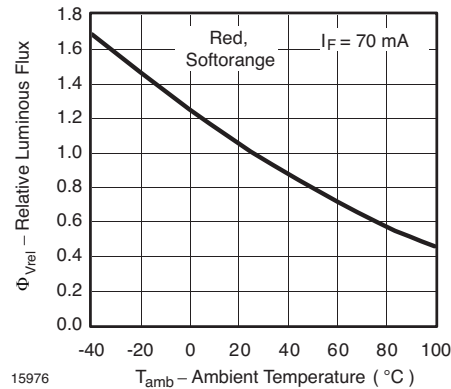

Figure 10. Rel. Luminous Flux vs. Ambient Temperature

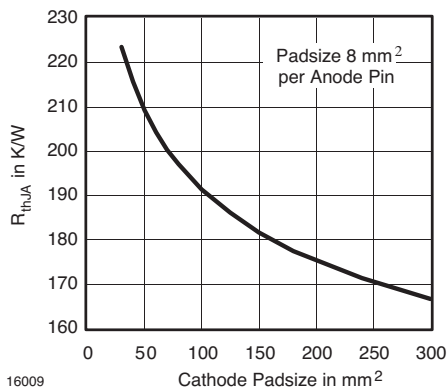

Figure 8. Thermal Resistance Junction Ambient vs. Cathode Padsize

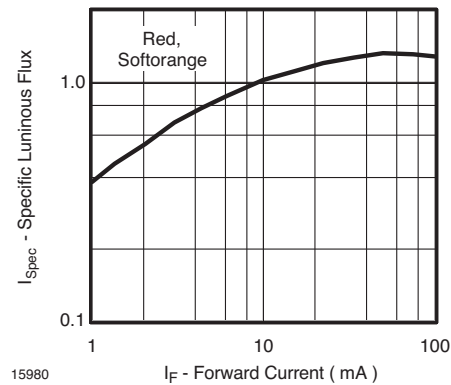

Figure 11. Specific Luminous Flux vs. Forward Current

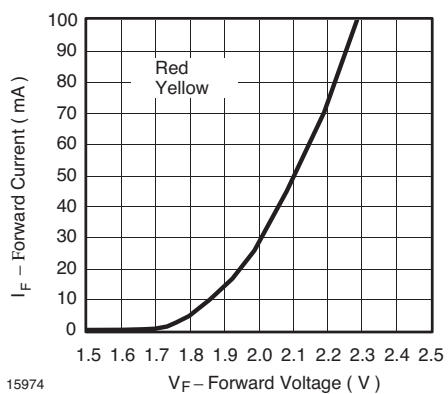

Figure 9. Forward Current vs. Forward Voltage

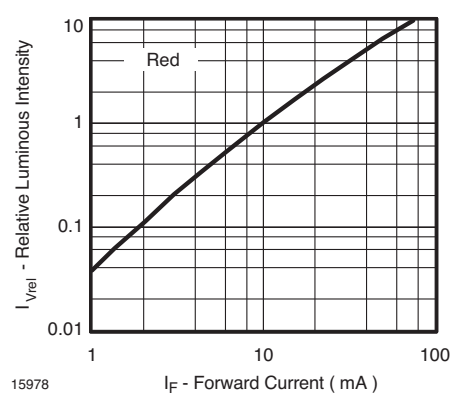

Figure 12. Relative Luminous Flux vs. Forward Current

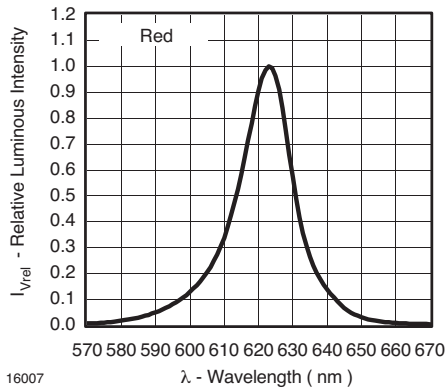

Figure 13. Relative Intensity vs. Wavelength

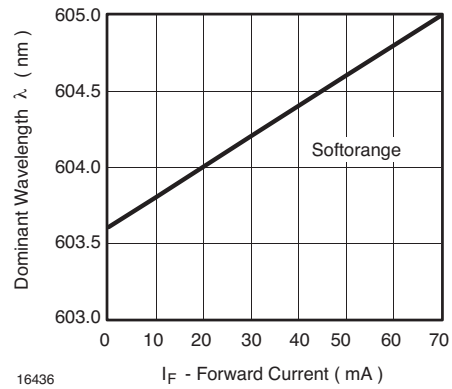

Figure 16. Dominant Wavelength vs. Forward Current

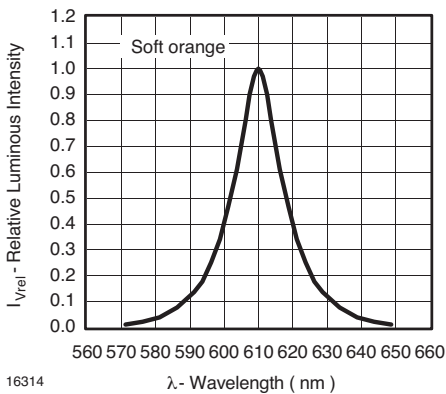

Figure 14. Relative Intensity vs. Wavelength

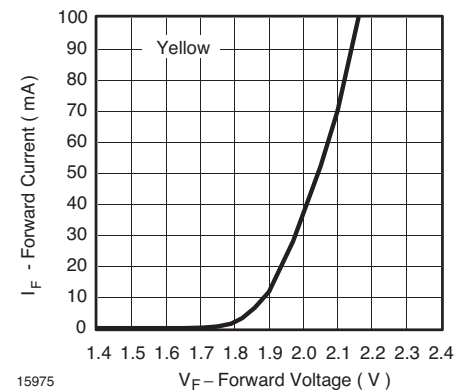

Figure 17. Forward Current vs. Forward Voltage

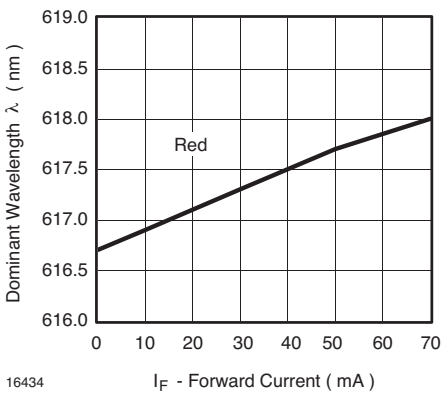

Figure 15. Dominant Wavelength vs. Forward Current

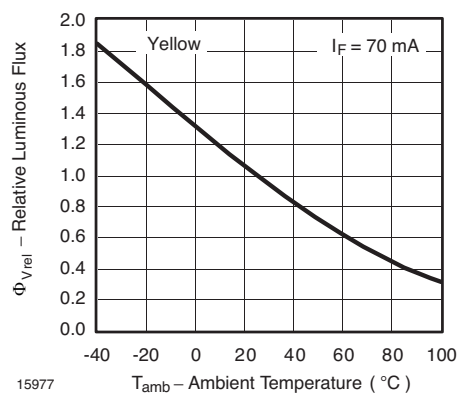
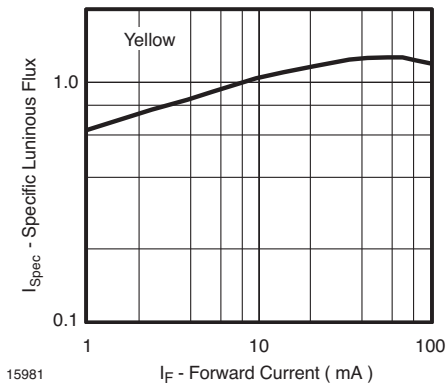
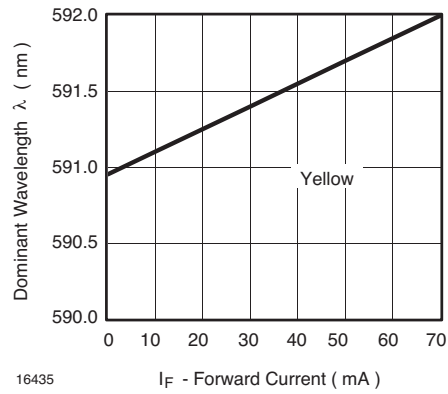

Figure 18. Rel. Luminous Flux vs. Ambient Temperature



15981
Figure 19. Specific Luminous Flux vs. Forward Current



16435
Figure 22. Dominant Wavelength vs. Forward Current

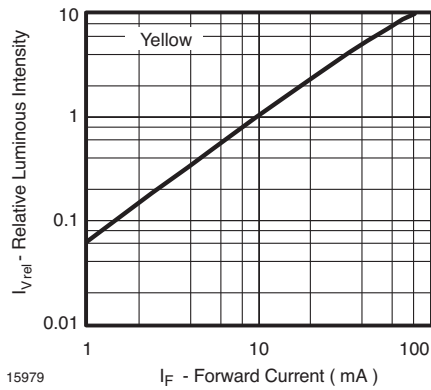

15979
Figure 20. Relative Luminous Flux vs. Forward Current

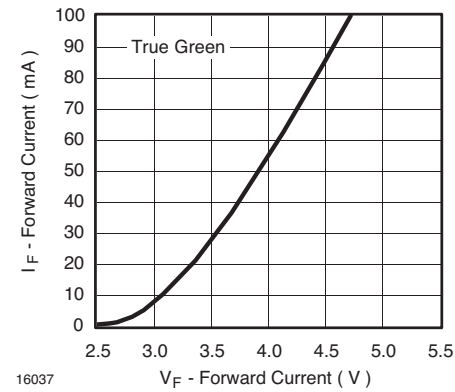

16037
Figure 23. Forward Current vs. Forward Voltage

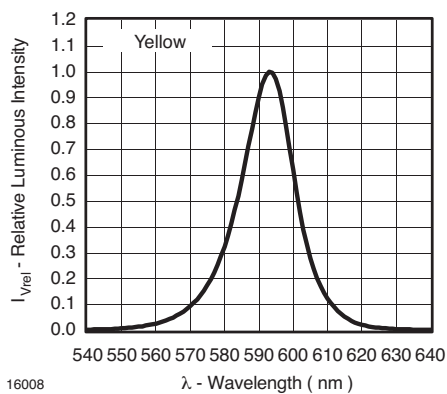

16008
Figure 21. Relative Intensity vs. Wavelength

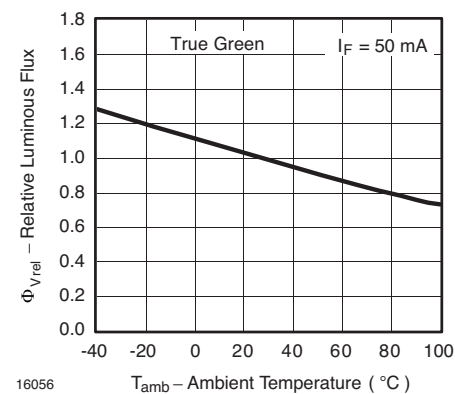

16056
Figure 24. Rel. Luminous Flux vs. Ambient Temperature

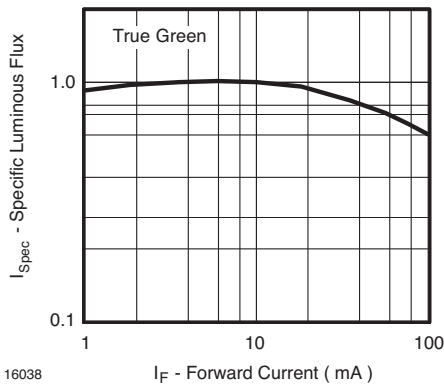

Figure 25. Specific Luminous Flux vs. Forward Current

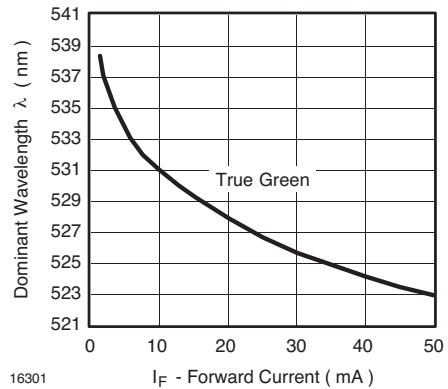

Figure 28. Dominant Wavelength vs. Forward Current

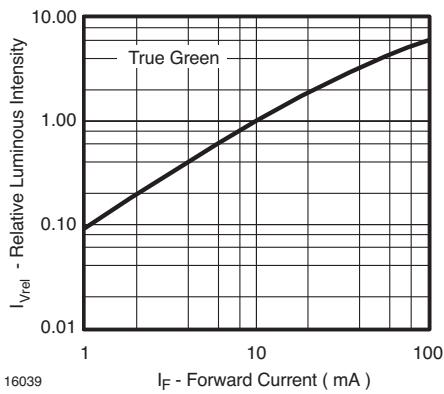

Figure 26. Relative Luminous Flux vs. Forward Current

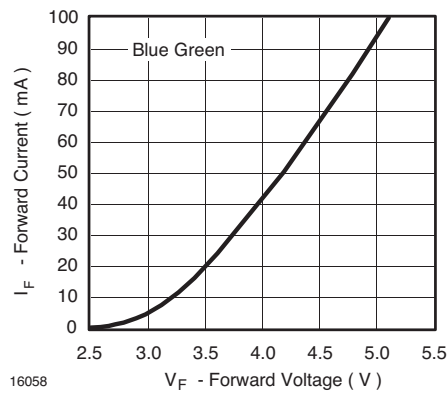

Figure 29. Forward Current vs. Forward Voltage

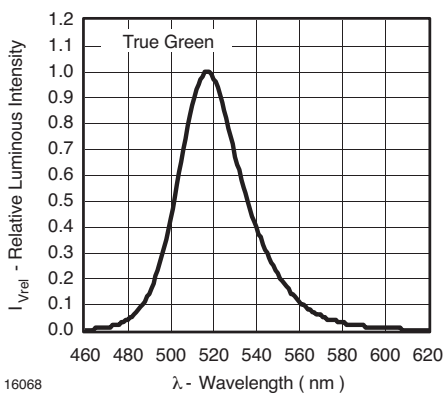

Figure 27. Relative Intensity vs. Wavelength

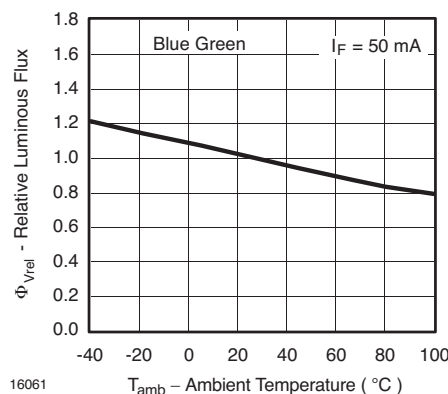
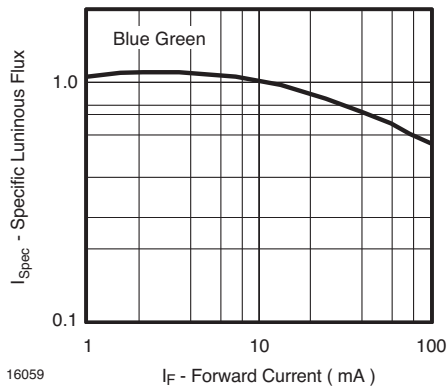
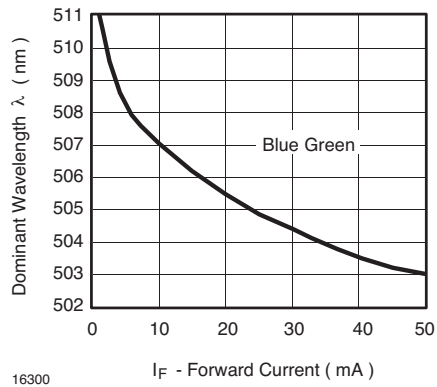

Figure 30. Rel. Luminous Flux vs. Ambient Temperature



16059
Figure 31. Specific Luminous Flux vs. Forward Current



16300
Figure 34. Dominant Wavelength vs. Forward Current

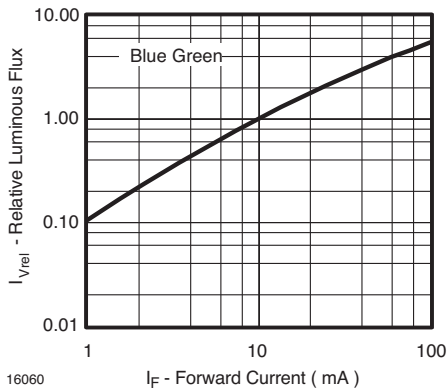

16060
Figure 32. Relative Luminous Flux vs. Forward Current

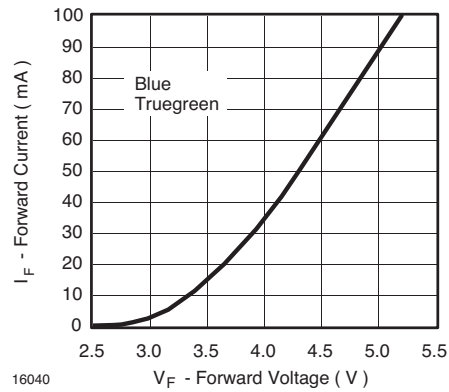

16040
Figure 35. Forward Current vs. Forward Voltage

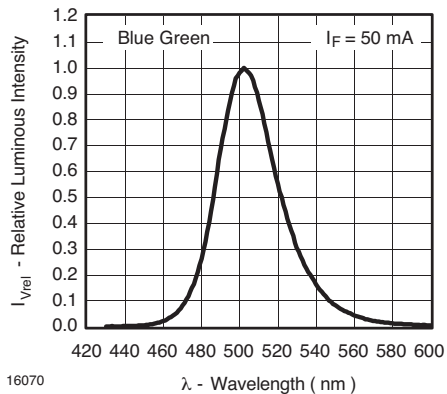

16070
Figure 33. Relative Intensity vs. Wavelength

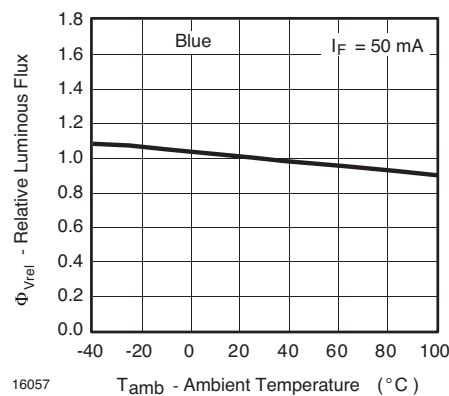

16057
Figure 36. Rel. Luminous Flux vs. Ambient Temperature

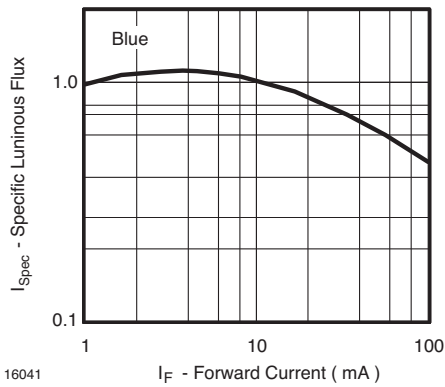

Figure 37. Specific Luminous Flux vs. Forward Current

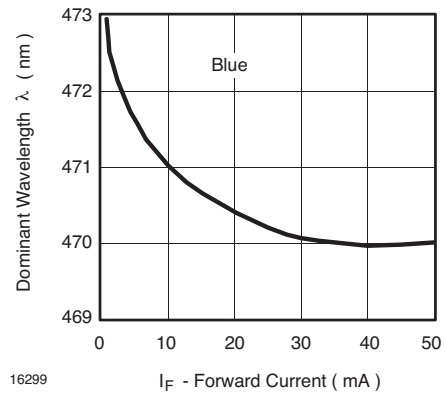

Figure 40. Dominant Wavelength vs. Forward Current

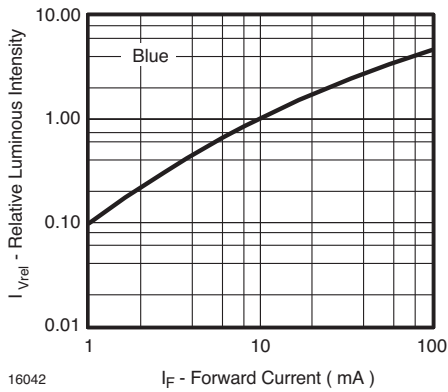

Figure 38. Relative Luminous Flux vs. Forward Current

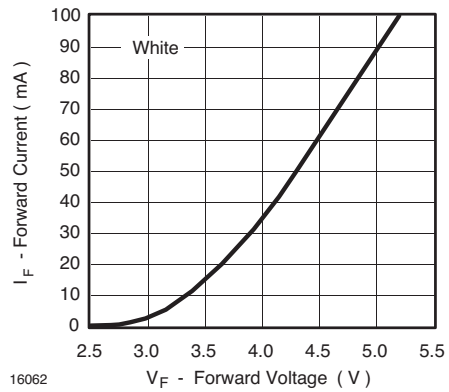

Figure 41. Forward Current vs. Forward Voltage

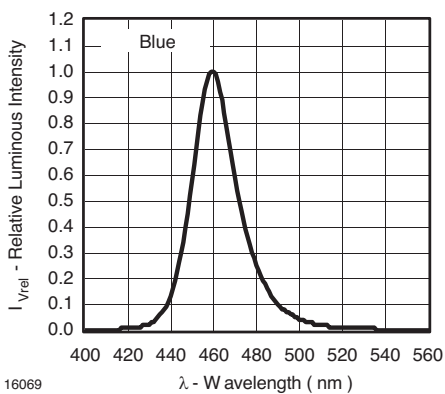

Figure 39. Relative Intensity vs. Wavelength

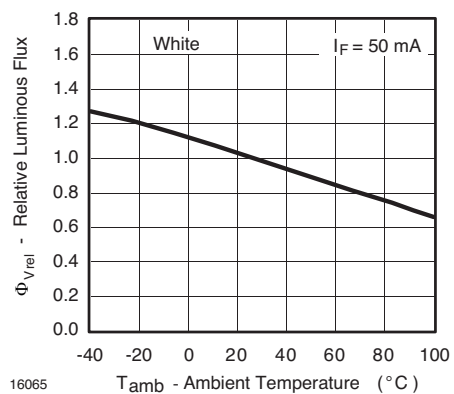

Figure 42. Rel. Luminous Flux vs. Ambient Temperature

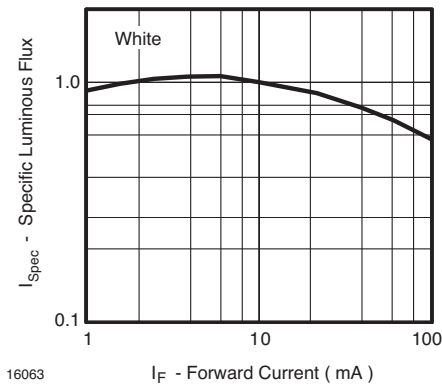

Figure 43. Specific Luminous Flux vs. Forward Current

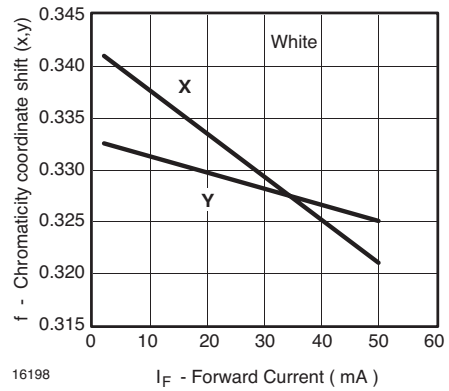

Figure 46. Chromaticity Coordinate Shift vs. Forward Current

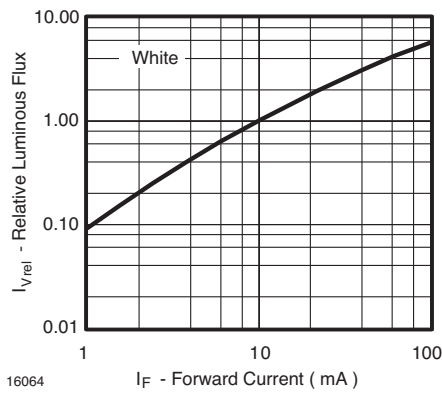

Figure 44. Relative Luminous Flux vs. Forward Current

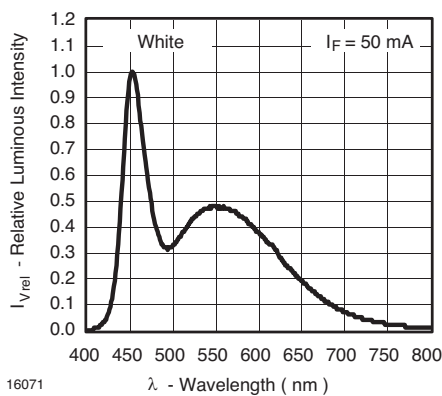
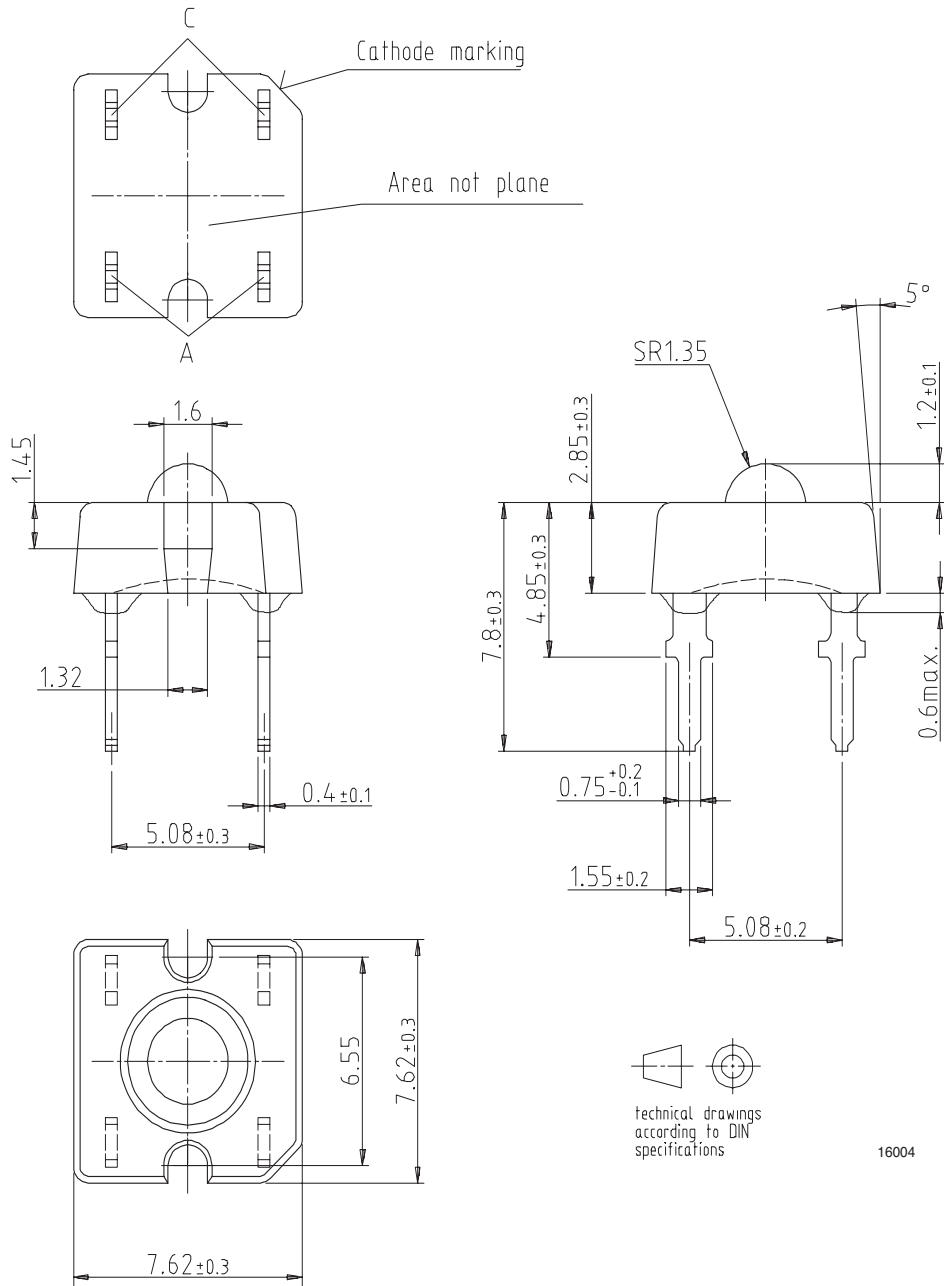

Figure 45. Relative Intensity vs. Wavelength

Package Dimensions in mm



Ozone Depleting Substances Policy Statement

It is the policy of Vishay Semiconductor GmbH to

1. Meet all present and future national and international statutory requirements.
2. Regularly and continuously improve the performance of our products, processes, distribution and operating systems with respect to their impact on the health and safety of our employees and the public, as well as their impact on the environment.

It is particular concern to control or eliminate releases of those substances into the atmosphere which are known as ozone depleting substances (ODSs).

The Montreal Protocol (1987) and its London Amendments (1990) intend to severely restrict the use of ODSs and forbid their use within the next ten years. Various national and international initiatives are pressing for an earlier ban on these substances.

Vishay Semiconductor GmbH has been able to use its policy of continuous improvements to eliminate the use of ODSs listed in the following documents.

1. Annex A, B and list of transitional substances of the Montreal Protocol and the London Amendments respectively
2. Class I and II ozone depleting substances in the Clean Air Act Amendments of 1990 by the Environmental Protection Agency (EPA) in the USA
3. Council Decision 88/540/EEC and 91/690/EEC Annex A, B and C (transitional substances) respectively.

Vishay Semiconductor GmbH can certify that our semiconductors are not manufactured with ozone depleting substances and do not contain such substances.

We reserve the right to make changes to improve technical design
and may do so without further notice.

Parameters can vary in different applications. All operating parameters must be validated for each customer application by the customer. Should the buyer use Vishay Semiconductors products for any unintended or unauthorized application, the buyer shall indemnify Vishay Semiconductors against all claims, costs, damages, and expenses, arising out of, directly or indirectly, any claim of personal damage, injury or death associated with such unintended or unauthorized use.

Vishay Semiconductor GmbH, P.O.B. 3535, D-74025 Heilbronn, Germany
Telephone: 49 (0)7131 67 2831, Fax number: 49 (0)7131 67 2423



Notice

Specifications of the products displayed herein are subject to change without notice. Vishay Intertechnology, Inc., or anyone on its behalf, assumes no responsibility or liability for any errors or inaccuracies.

Information contained herein is intended to provide a product description only. No license, express or implied, by estoppel or otherwise, to any intellectual property rights is granted by this document. Except as provided in Vishay's terms and conditions of sale for such products, Vishay assumes no liability whatsoever, and disclaims any express or implied warranty, relating to sale and/or use of Vishay products including liability or warranties relating to fitness for a particular purpose, merchantability, or infringement of any patent, copyright, or other intellectual property right.

The products shown herein are not designed for use in medical, life-saving, or life-sustaining applications. Customers using or selling these products for use in such applications do so at their own risk and agree to fully indemnify Vishay for any damages resulting from such improper use or sale.