

SPECIFICATIONS

CONTACT RATING: 5A @125 VAC or 28 VDC (Q terminal)
 ELECTRICAL LIFE: 50,000 make-and-break cycles at full load
 CONTACT RESISTANCE: 10 mΩ max. initial @2-4 VDC, 100 mA
 INSULATION RESISTANCE: 1,000 MΩ min.
 DIELECTRIC STRENGTH: 1,500 V RMS @ sea level.
 OPERATING TEMPERATURE: -30 °C to +85 °C

MATERIALS

CASE - diallyl phthalate (DAP)
 Actuator - ABS ,black standard.
 Frame - Nylon (UL 94V-0) ,black
 BUSHING - Copper alloy or Zinc , nickel plated
 HOUSING - Stainless Steel
 CONTACT AND TERMINAL - Copper alloy, silver plated

How do you build the switches you need!!

The straight terminal type , please see the (A) ;

The right angle P.C terminals, please see the (B)

(A) R 8 0 1 5 - R 1 1 - 2 - C - Q - E - S 2 0 -

Switches Function			Actuator	Actuator Color	Frame Color	Termination	Vertical support Bracket	
R8015	SP	R8017 DP	R11	1 white	1 white	B solder lug	(none)	
R8015A	SP	R8017A DP	R21	2 black(std)	2 black	C P.C 1.27width	S20 11.68	
R8016	SP	R8018 DP	P13	3 red	3 red	D Quick connect	S25 16.00	
R8016A	SP	R8018A DP	P23	4 orange		D1 wire wrap 19.05	S35 11.68	
R8016B	SP	R8018B DP	R15	5 yellow		D3 wire wrap 10.8	S40 16.00	
R8301V	3P	R8401V 4P	R17	6 green			V20 snap-in 11.68	
R8303V	3P	R8403V 4P	R12	7 blue			V25 snap-in 16.00	
R8305V	3P	R8405V 4P	R22	8 brown			V35 snap-in 11.68	
R8307V	3P	R8407V 4P	R32	9 gray			V40 snap-in 16.00	
R8309V	3P	R8409V 4P	P14					
			P24					
			P34					
3 way position switches			now the available is code "1/2/3/4/7/9" the other please inquire first					
R818		SP3T on-on-on						
R818A		SP3T (on)-on-(on)						
R818B		SP3T on-on-(on)						
R845V		DP3T on-on-on						
R847V		DP3T (on)-on-(on)						
R849V		DP3T on-on-(on)						
			RoHS code					H = RoHS Compliant
			Epoxy seal					
			(none) none seal					
			E epoxy seal					

(B) R 8 0 1 5 P - R 1 1 - 2 - Q - E - S -

Horizon Right Angle	Vertical Right Angle	Switches Function	Actuator	Actuator Color	Contact Material	RoHS code	
R8015P	R8015L / R8013L	SP on-none-on	R11	1 white	Q silver plated	H = RoHS Compliant	
R8015PA	R8015LA / R8013LA	SP on-none-(on)	R21	2 black(std)	R gold plated		
R8016P	R8016L / R8014L	SP on-off-on	R17	3 red	G gold over silver		
R8016PA	R8016LA / R8014LA	SP (on)-off-(on)	P13	4 orange	K tin plated		
R8016PB	R8016LB / R8014LB	SP on-off-(on)	P23	5 yellow			
R8017P	R8017L / R8011L	DP on-none-on		6 green			
R8017PA	R8017LA / R8011LA	DP on-none-(on)	The right angle type cannot have frame.	7 blue			
R8018P	R8018L / R8012L	DP on-off-on		8 brown			
R8018PA	R8018LA / R8012LA	DP (on)-off-(on)		9 gray			
R8018PB	R8018LB / R8012LB	DP on-off-(on)					
	R8301L	3P on-none-on					
	R8303L	3P on-none-(on)					
	R8305L	3P on-off-on					
	R8307L	3P (on)-off-(on)					
	R8309L	3P on-off-(on)					
	R8401L	4P on-none-on					
	R8403L	4P on-none-(on)					
	R8405L	4P on-off-on					
	R8407L	4P (on)-off-(on)					
	R8409L	4P on-off-(on)					
3 way position switches							
	R818P/R818L/ R812L	SP3T on-on-on					
	R818PA/R818LA/R812LA	SP3T (on)-on-(on)					
	R818PB/R818LB/R812LB	SP3T on-on-(on)					
	R845L	DP3T on-on-on					
	R847L	DP3T (on)-on-(on)					
	R849L	DP3T on-on-(on)					
			Epoxy seal				
			(none) none seal				
			E epoxy seal				
			Support Bracket type				
			(none) std.				
			S snap-in type				

SPDT

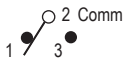

Model No.	Switching position		
R8015	ON	none	ON
R8015A	ON	none	(ON)
R8016	ON	OFF	ON
R8016A	(ON)	OFF	(ON)
R8016B	ON	OFF	(ON)
Term. Comm.	2-3	open	2-1

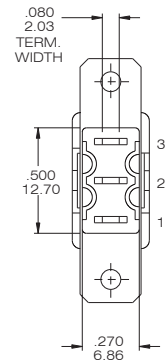
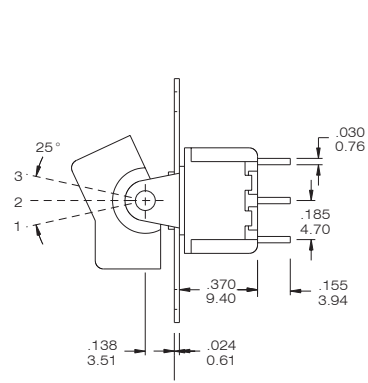
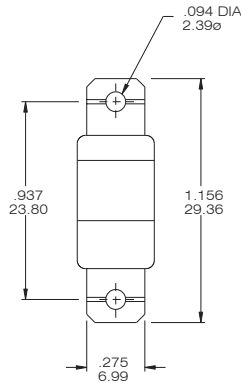

R8015 - R11-2-BQ

DPDT



Model No.	Switching position		
R8017	ON	none	ON
R8017A	ON	none	(ON)
R8018	ON	OFF	ON
R8018A	(ON)	OFF	(ON)
R8018B	ON	OFF	(ON)
Term. Comm.	2-3,5-6	open	2-1,5-4
3 way switches (SP3T)			
R818	ON	ON	ON
R818A	(ON)	ON	(ON)
R818B	ON	ON	(ON)
Term. Comm.	2-3,5-6	2-3,5-4	2-1,5-4

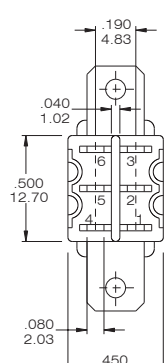
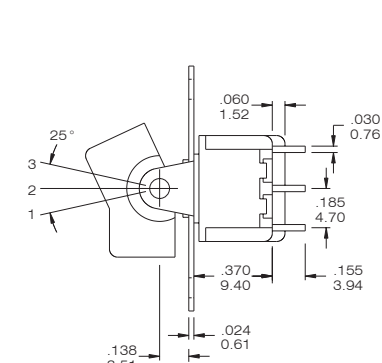
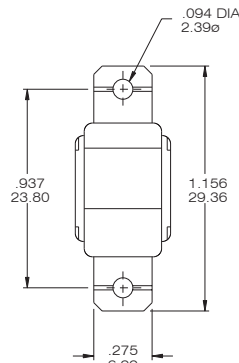

R8017 - R11-2-BQ

Please see page B12 to know more about R818 (3-way Switches)

3PDT

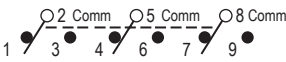

Model No.	Switching position		
R8301V	ON	none	ON
R8303V	ON	none	(ON)
R8305V	ON	OFF	ON
R8307V	(ON)	OFF	(ON)
R8309V	ON	OFF	(ON)
Term. Comm.	2-3,5-6 8-9	open	2-1,5-4 8-7

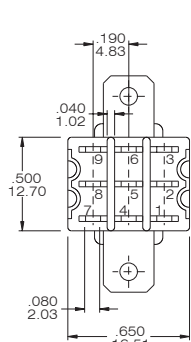
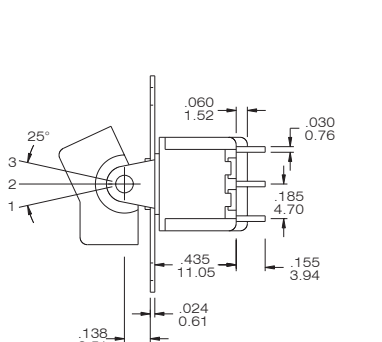
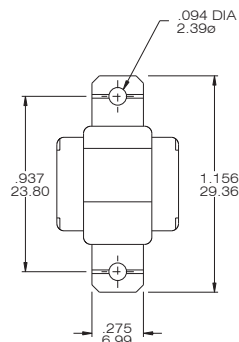

R8301V- R11-2-BQ

4PDT



Model No.	Switching position		
R8401V	ON	none	ON
R8403V	ON	none	(ON)
R8405V	ON	OFF	ON
R8407V	(ON)	OFF	(ON)
R8409V	ON	OFF	(ON)
Term. Comm.	2-3,5-6 8-9,11-12	open	2-1,5-4 8-7,11-10
3 way switches (DP3T)			
R845V	ON	ON	ON
R847V	(ON)	ON	(ON)
R849V	ON	ON	(ON)
Term. Comm.	2-3,5-6 8-9,11-12	2-3,5-4 8-9,11-10	2-1,5-4 8-7,11-10

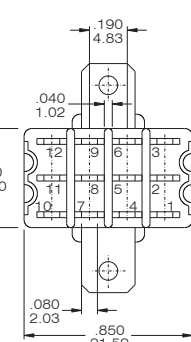
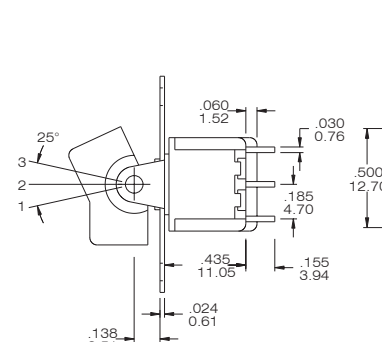
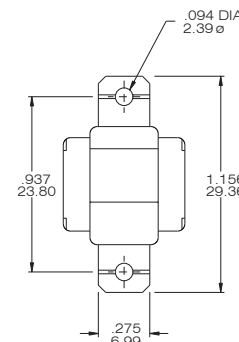

R8401V -R11-2-BQ

Please see page B12 to know more about R845V (3-way Switches)

HORISON RIGHT ANGLE

SPDT



Model No.	Switching position		
R8015P	ON	none	ON
R8015PA	ON	none	(ON)
R8016P	ON	OFF	ON
R8016PA	(ON)	OFF	(ON)
R8016PB	ON	OFF	(ON)
Term. Comm.	2-3	open	2-1

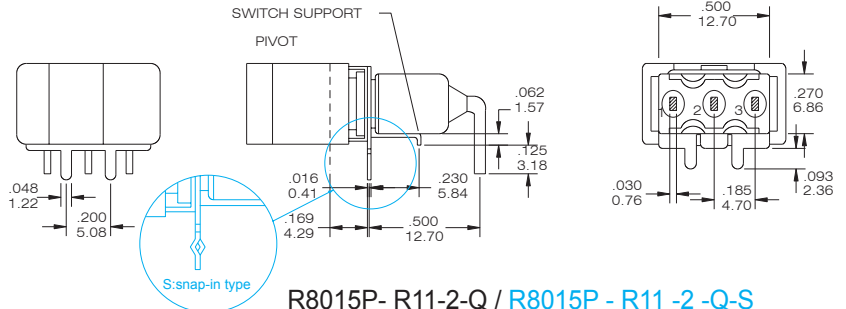

DPDT



Model No.	Switching position		
R8017P	ON	none	ON
R8017PA	ON	none	(ON)
R8018P	ON	OFF	ON
R8018PA	(ON)	OFF	(ON)
R8018PB	ON	OFF	(ON)
Term. Comm.	2-3,5-6	open	2-1,5-4
3 way switches (SP3T)			
R818P	ON	ON	ON
R818PA	(ON)	ON	(ON)
R818PB	ON	ON	(ON)
Term. Comm.	2-3,5-6	2-3,5-4	2-1,5-4

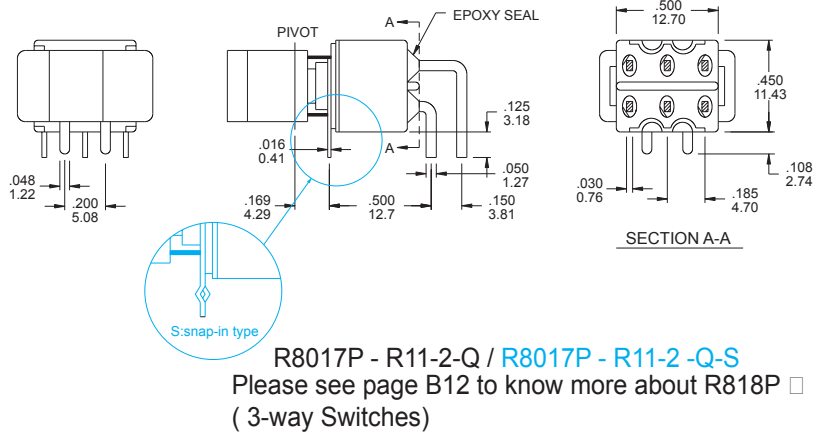

VERTICAL RIGHT ANGLE

SPDT

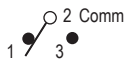
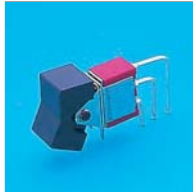

Model No.	Switching position		
R8015L	ON	none	ON
R8015LA	ON	none	(ON)
R8016L	ON	OFF	ON
R8016LA	(ON)	OFF	(ON)
R8016LB	ON	OFF	(ON)
Term. Comm.	2-3	open	2-1

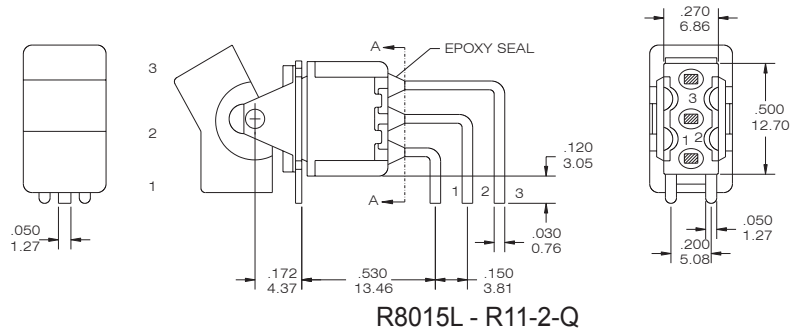

SPDT

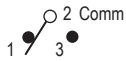

Model No.	Switching position		
R8013L	ON	none	ON
R8013LA	ON	none	(ON)
R8014L	ON	OFF	ON
R8014LA	(ON)	OFF	(ON)
R8014LB	ON	OFF	(ON)
Term. Comm.	2-3	open	2-1

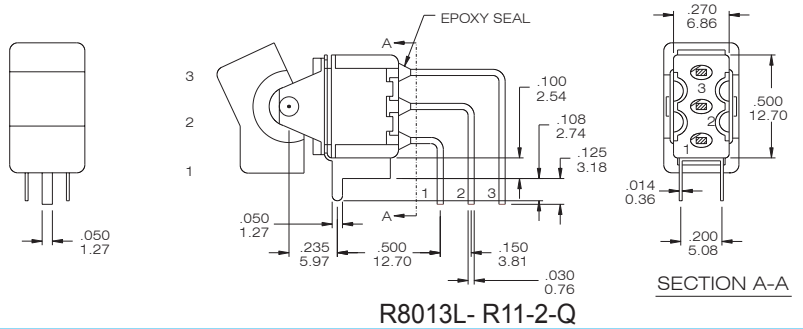

DPDT



Model No.	Switching position		
R8017L	ON	none	ON
R8017LA	ON	none	(ON)
R8018L	ON	OFF	ON
R8018LA	(ON)	OFF	(ON)
R8018LB	ON	OFF	(ON)
Term. Comm.	2-3,5-6	open	2-1,5-4
3 way switches (SP3T)			
R818L	ON	ON	ON
R818LA	(ON)	ON	(ON)
R818LB	ON	ON	(ON)
Term. Comm.	2-3,5-6	2-3,5-4	2-1,5-4

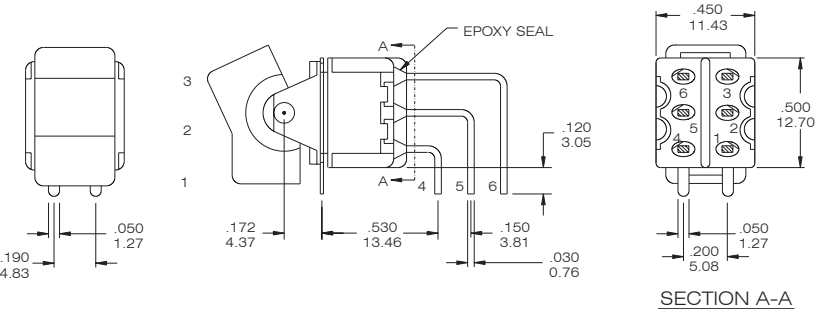

VERTICAL RIGHT ANGLE PAGE

DPDT



Model No.	Switching position		
R8011L	ON	none	ON
R8011LA	ON	none	(ON)
R8012L	ON	OFF	ON
R8012LA	(ON)	OFF	(ON)
R8012LB	ON	OFF	(ON)
Term. Comm.	2-3,5-6	open	2-1,5-4
3 way switches (SP3T)			
R812L	ON	ON	ON
R812LA	(ON)	ON	(ON)
R812LB	ON	ON	(ON)
Term. Comm.	2-3,5-6	2-3,5-4	2-1,5-4

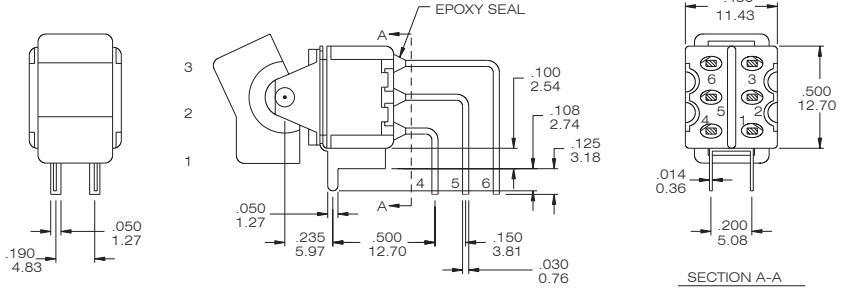

R8011L - R11-2-Q
Please see page B12 to know more about R812L (3-way Switches)

3PDT

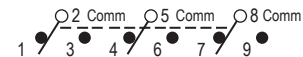

Model No.	Switching position		
R8301L	ON	none	ON
R8303L	ON	none	(ON)
R8305L	ON	OFF	ON
R8307L	(ON)	OFF	(ON)
R8309L	ON	OFF	(ON)
Term. Comm.	2-3,5-6 8-9	open	2-1,5-4 8-7

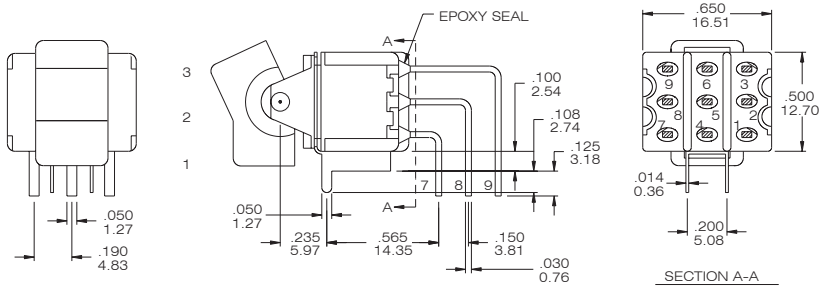

R8301L - R11-2-Q

4PDT

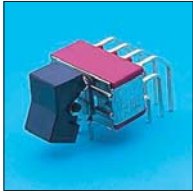

Model No.	Switching position		
R8401L	ON	none	ON
R8403L	ON	none	(ON)
R8405L	ON	OFF	ON
R8407L	(ON)	OFF	(ON)
R8409L	ON	OFF	(ON)
Term. Comm.	2-3,5-6 8-9,11-12	open	2-1,5-4 8-7,11-10
3 way switches (DP3T)			
R845L	ON	ON	ON
R847L	(ON)	ON	(ON)
R849L	ON	ON	(ON)
Term. Comm.	2-3,5-6 8-9,11-12	2-3,5-4 8-9,11-10	2-1,5-4 8-7,11-10

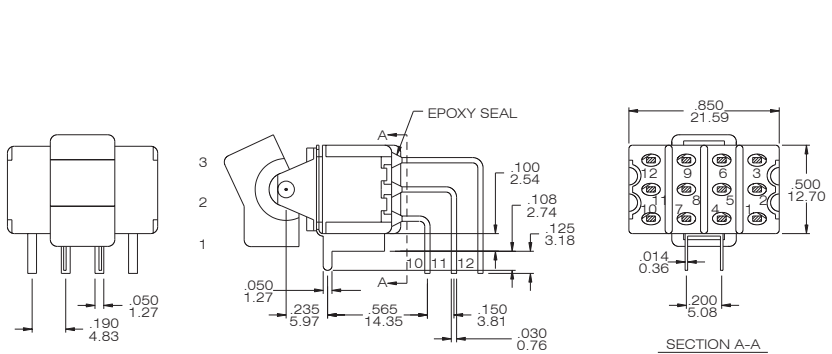

R8401L - R11-2-Q
Please see page B12 to know more about R845L (3-way Switches)

FOR R8015P-R8016P

FOR R8017P-R8018P

FOR R8015L-R8016L

FOR R8013L-R8014L

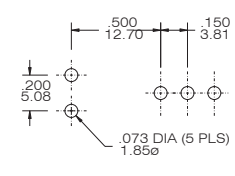
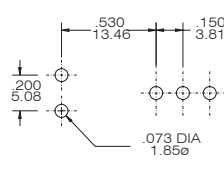
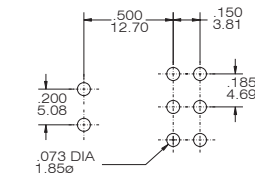
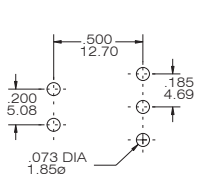

FOR R8017L-R8018L

FOR R8011L-R8012L

FOR R8301L-R8309L

FOR R8401L-R8409L

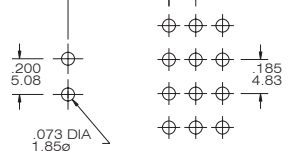
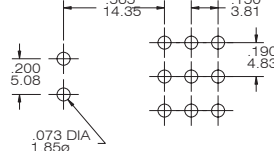
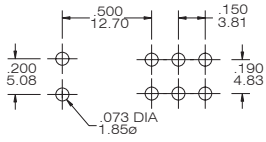
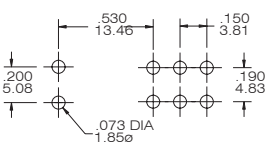



Actuator Option(PANEL REAR MOUNT) only for the straight type (Page B-06)

R11

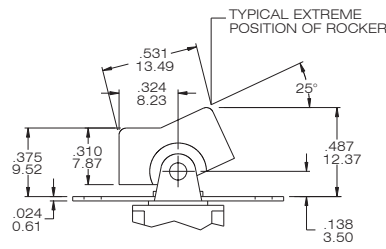
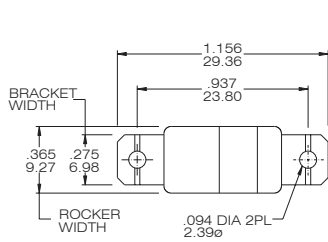

PANELMOUNTING

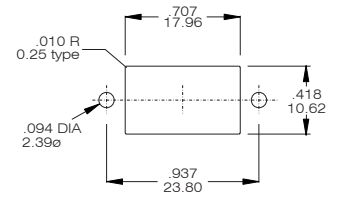

R21

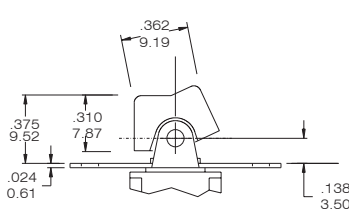
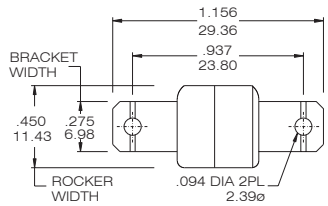

PANELMOUNTING

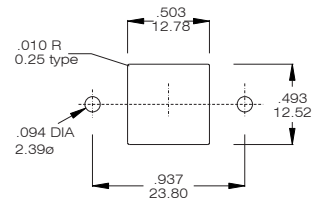

P13

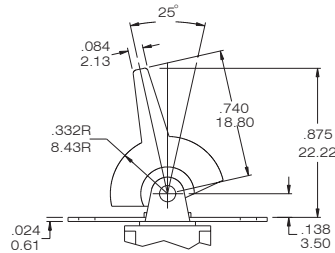
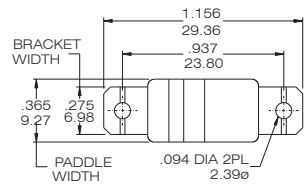

PANELMOUNTING

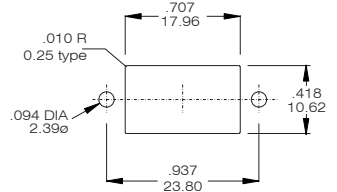

P23

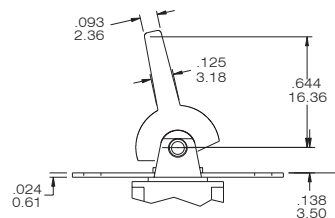
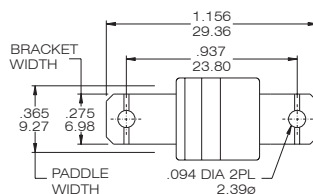

PANELMOUNTING

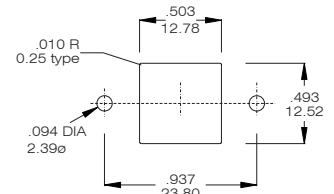

R15

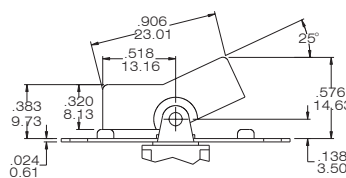
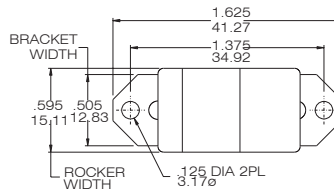

PANELMOUNTING

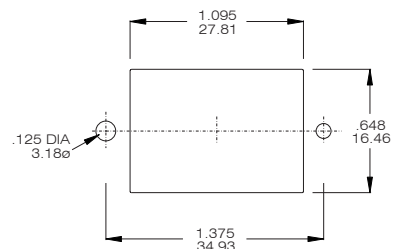

R17

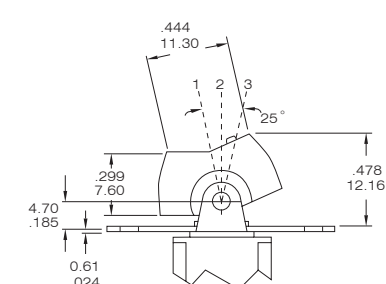
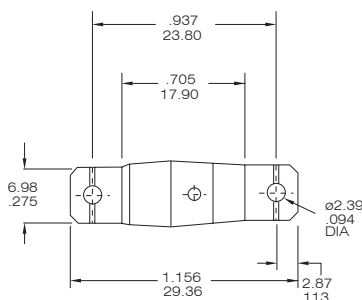

PANELMOUNTING

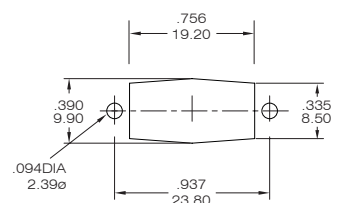



Actuator Option(SNAP-IN FRONT MOUNT) only for the straight type (Page B-06)

R12

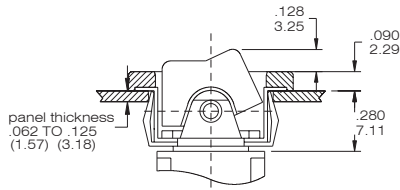
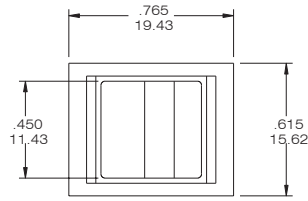

PANEL MOUNTING

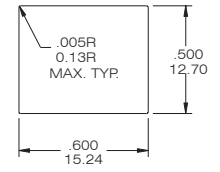

R22

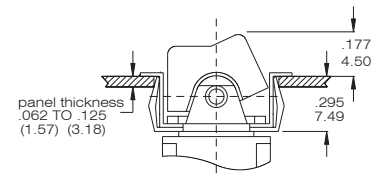
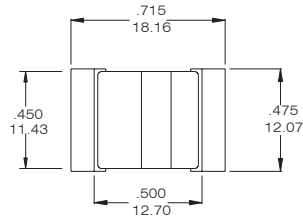

PANEL MOUNTING

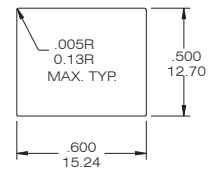

R32

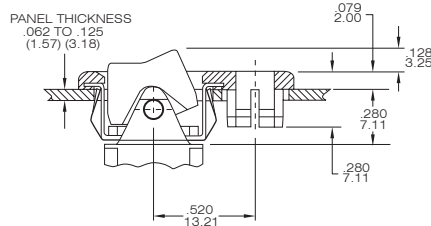
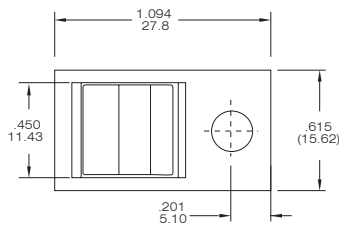

PANEL MOUNTING

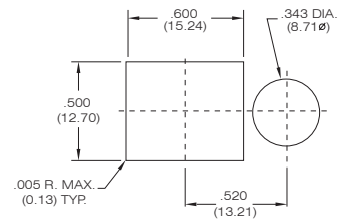

P14

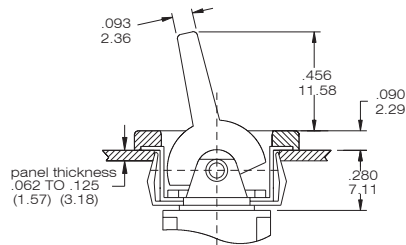
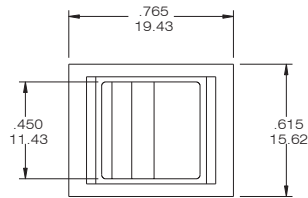
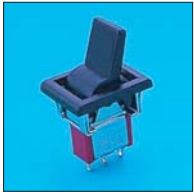

PANEL MOUNTING

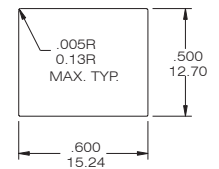

P24

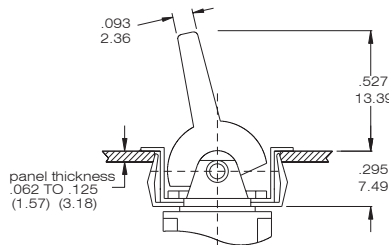
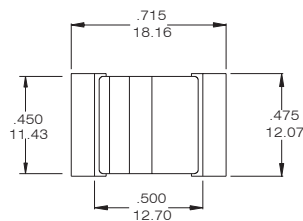

PANEL MOUNTING

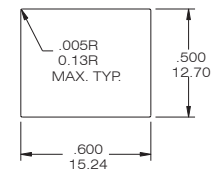

P34

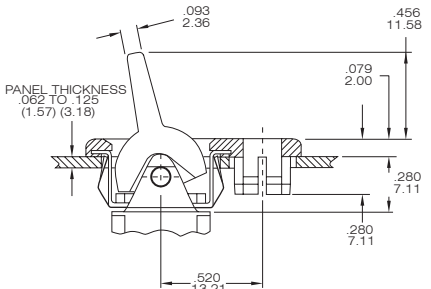
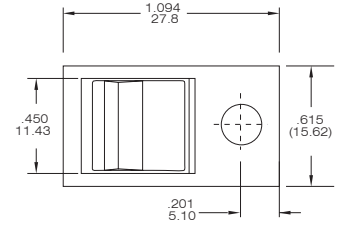

PANEL MOUNTING

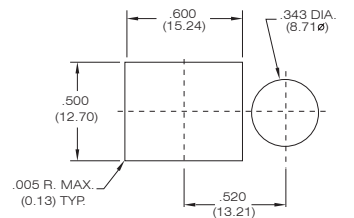

INDEX

TOGGLE

ROCKER

SLIDE

PUSHBUTTON

DIP

TACT

Actuator Option (P.C.B MOUNT)

R11

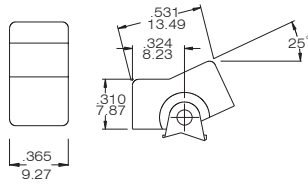

R21

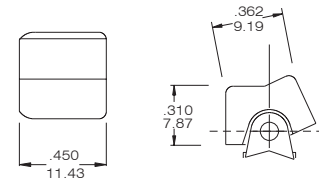

P13

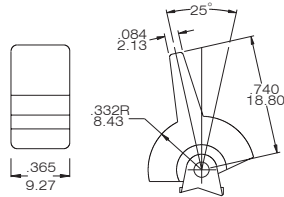

P23

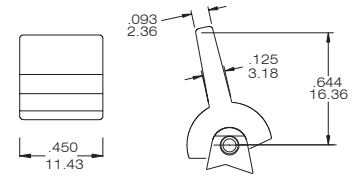

Actuator Color Option

ACTUATOR AND FRAME COLORS								
1	White	4	Orange	7	Blue			
2	Black(Std.)	5	Yellow	8	Brown			
3	Red	6	Green	9	Gray			

R15

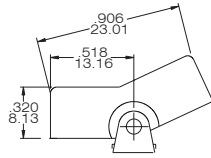
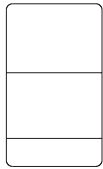

TERMINAL OPTION (ONLY FOR THE STRAIGHT TYPE R8015~R8401)

TERMINAL SEAL OPTION

B SOLDER LUG

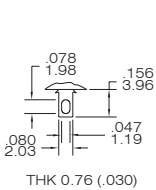

C PRINTED CIRCUIT

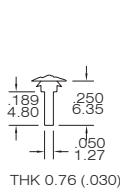

D QUICK CONNECT

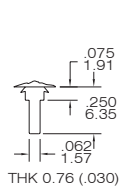

WIREWRAP

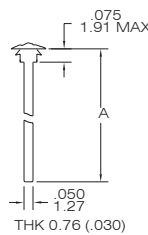

CODE	"A" dimension
D1	.750 (19.05)
D3	.425 (10.8)

E TERMINAL SEAL

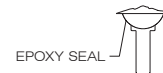

CONTACT MATERIAL OPTIONS

CODE	CONTACT MATERIAL	TERMINAL MATERIAL	RATING
Q	Silver plated	Silver plated	5 A @ 125 V AC or 28 V DC; 3 A @ 250 VAC
R	Gold plated over nickel plated	Gold plated over nickel plated	0.4VA MAX @ 20 V AC or DC MAX
G	Gold plated over silver plated	Gold plated over silver plated	0.4 VA MAX @ 20 V AC or DC MAX or 5 A @ 125V AC or 28 V DC; 3 A @ 250 VAC
K	Gold plated over nickel plated	Tin over nickel plated	0.4VA MAX @ 20 V AC or DC MAX

* THE K option is only for some special item. Please inquire first when you need the "K" option



VERTICAL SUPPORT BRACKET OPTION

(only apply the straight type terminal -page B06. Please build the terminal option is "c" code)

S20 / S25/ V20/V25

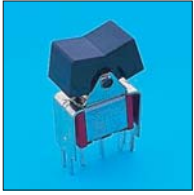

SPDT

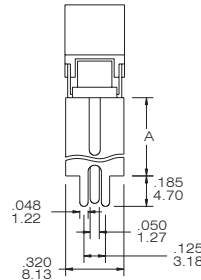
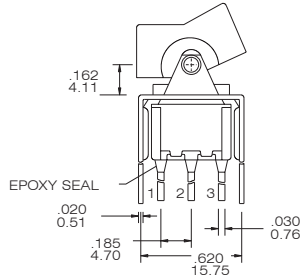

P.C. MOUNTING

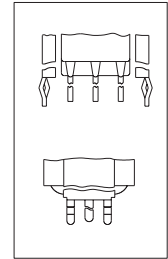
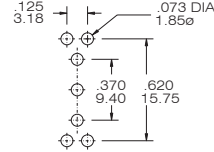

SNAP-IN
V20/ V25

R8015-R11-2-CQ-S20(S25)

DPDT

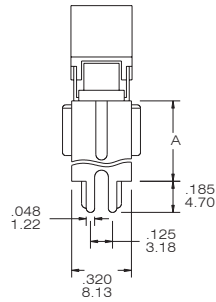
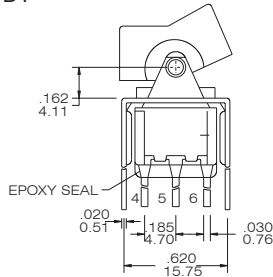

P.C. MOUNTING

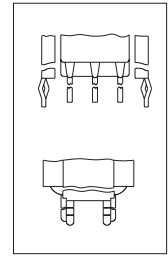
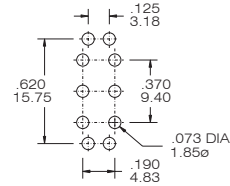

SNAP-IN
V20/ V25

R8017 - R11-2-CQ-S20(S25)

S35/S40 /V35/V40



SPDT

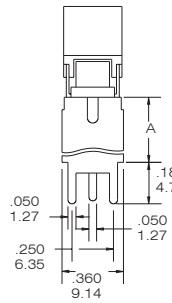
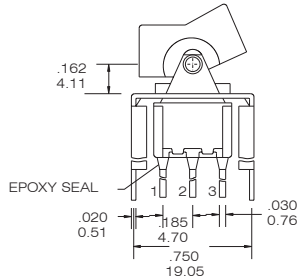

P.C. MOUNTING

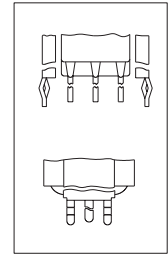
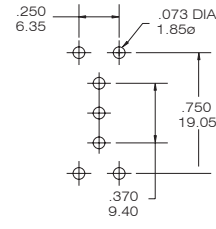

SNAP-IN
V35/ V40

R8015-R11-2-CQ-S35(S40)

DPDT

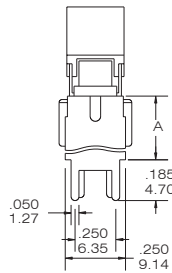
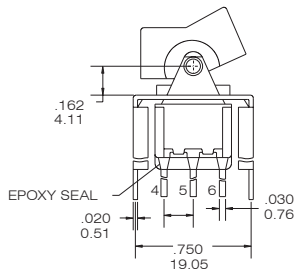

P.C. MOUNTING

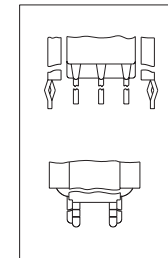
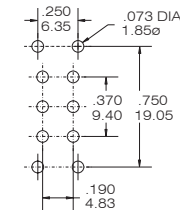

SNAP-IN
V35/ V40

R8017-R11-2-CQ-S35(S40)

The information of 3-way rocker switches

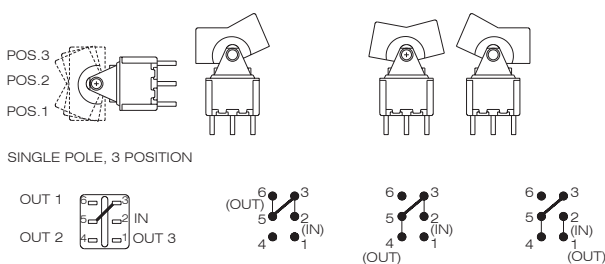

SP3T

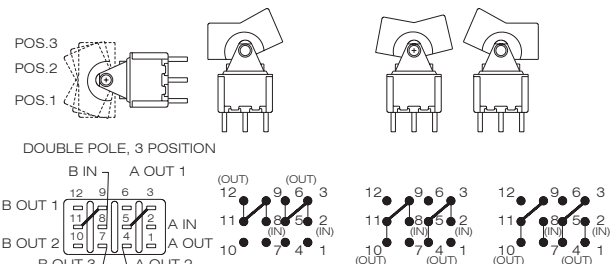

DP3T