



SL876Q5-A

Product User Guide

1VV0301333 Rev. 2

2017-06-27

TELIT
TECHNICAL
DOCUMENTATION

SPECIFICATIONS ARE SUBJECT TO CHANGE WITHOUT NOTICE

NOTICE

While reasonable efforts have been made to assure the accuracy of this document, Telit assumes no liability resulting from any inaccuracies or omissions in this document, or from use of the information obtained herein. The information in this document has been carefully checked and is believed to be reliable. However, no responsibility is assumed for inaccuracies or omissions. Telit reserves the right to make changes to any products described herein and reserves the right to revise this document and to make changes from time to time in content hereof with no obligation to notify any person of revisions or changes. Telit does not assume any liability arising out of the application or use of any product, software, or circuit described herein; neither does it convey license under its patent rights or the rights of others.

It is possible that this publication may contain references to, or information about Telit products (machines and programs), programming, or services that are not announced in your country. Such references or information must not be construed to mean that Telit intends to announce such Telit products, programming, or services in your country.

COPYRIGHTS

This instruction manual and the Telit products described in this instruction manual may be, include or describe copyrighted Telit material, such as computer programs stored in semiconductor memories or other media. Laws in the Italy and other countries preserve for Telit and its licensors certain exclusive rights for copyrighted material, including the exclusive right to copy, reproduce in any form, distribute and make derivative works of the copyrighted material. Accordingly, any copyrighted material of Telit and its licensors contained herein or in the Telit products described in this instruction manual may not be copied, reproduced, distributed, merged or modified in any manner without the express written permission of Telit. Furthermore, the purchase of Telit products shall not be deemed to grant either directly or by implication, estoppel, or otherwise, any license under the copyrights, patents or patent applications of Telit, as arises by operation of law in the sale of a product.

COMPUTER SOFTWARE COPYRIGHTS

The Telit and 3rd Party supplied Software (SW) products described in this instruction manual may include copyrighted Telit and other 3rd Party supplied computer programs stored in semiconductor memories or other media. Laws in the Italy and other countries preserve for Telit and other 3rd Party supplied SW certain exclusive rights for copyrighted computer programs, including the exclusive right to copy or reproduce in any form the copyrighted computer program. Accordingly, any copyrighted Telit or other 3rd Party supplied SW computer programs contained in the Telit products described in this instruction manual may not be copied (reverse engineered) or reproduced in any manner without the express written permission of Telit or the 3rd Party SW supplier. Furthermore, the purchase of Telit products shall not be deemed to grant either directly or by implication, estoppel, or otherwise, any license under the copyrights, patents or patent applications of Telit or other 3rd Party supplied SW, except for the normal non-exclusive, royalty free license to use that arises by operation of law in the sale of a product.

USAGE AND DISCLOSURE RESTRICTIONS

I. License Agreements

The software described in this document is the property of Telit and its licensors. It is furnished by express license agreement only and may be used only in accordance with the terms of such an agreement.

II. Copyrighted Materials

Software and documentation are copyrighted materials. Making unauthorized copies is prohibited by law. No part of the software or documentation may be reproduced, transmitted, transcribed, stored in a retrieval system, or translated into any language or computer language, in any form or by any means, without prior written permission of Telit

III. High Risk Materials

Components, units, or third-party products used in the product described herein are NOT fault-tolerant and are NOT designed, manufactured, or intended for use as on-line control equipment in the following hazardous environments requiring fail-safe controls: the operation of Nuclear Facilities, Aircraft Navigation or Aircraft Communication Systems, Air Traffic Control, Life Support, or Weapons Systems (High Risk Activities"). Telit and its supplier(s) specifically disclaim any expressed or implied warranty of fitness for such High Risk Activities.

IV. Trademarks

TELIT and the Stylized T Logo are registered in Trademark Office. All other product or service names are the property of their respective owners.

V. Third Party Rights

The software may include Third Party Right software. In this case you agree to comply with all terms and conditions imposed on you in respect of such separate software. In addition to Third Party Terms, the disclaimer of warranty and limitation of liability provisions in this License shall apply to the Third Party Right software.

TELIT HEREBY DISCLAIMS ANY AND ALL WARRANTIES EXPRESS OR IMPLIED FROM ANY THIRD PARTIES REGARDING ANY SEPARATE FILES, ANY THIRD PARTY MATERIALS INCLUDED IN THE SOFTWARE, ANY THIRD PARTY MATERIALS FROM WHICH THE SOFTWARE IS DERIVED (COLLECTIVELY "OTHER CODE"), AND THE USE OF ANY OR ALL THE OTHER CODE IN CONNECTION WITH THE SOFTWARE, INCLUDING (WITHOUT LIMITATION) ANY WARRANTIES OF SATISFACTORY QUALITY OR FITNESS FOR A PARTICULAR PURPOSE.

NO THIRD PARTY LICENSORS OF OTHER CODE SHALL HAVE ANY LIABILITY FOR ANY DIRECT, INDIRECT, INCIDENTAL, SPECIAL, EXEMPLARY, OR CONSEQUENTIAL DAMAGES (INCLUDING WITHOUT LIMITATION LOST PROFITS), HOWEVER CAUSED AND WHETHER MADE UNDER CONTRACT, TORT OR OTHER LEGAL THEORY, ARISING IN ANY WAY OUT OF THE USE OR DISTRIBUTION OF THE OTHER CODE OR THE EXERCISE OF ANY RIGHTS GRANTED UNDER EITHER OR BOTH THIS LICENSE AND THE LEGAL TERMS APPLICABLE TO ANY SEPARATE FILES, EVEN IF ADVISED OF THE POSSIBILITY OF SUCH DAMAGES.

PRODUCT APPLICABILITY TABLE

Product
SE876Q5-A

CONTENTS

NOTICE	2
COPYRIGHTS	2
COMPUTER SOFTWARE COPYRIGHTS	2
USAGE AND DISCLOSURE RESTRICTIONS	3
PRODUCT APPLICABILITY TABLE	4
1. INTRODUCTION	11
1.1. Purpose	11
1.2. Contact and Support Information	11
1.3. Text Conventions	12
1.4. Related Documents	13
1.4.1. Related Documents Requiring a Non-disclosure Agreement	13
2. PRODUCT DESCRIPTION	14
2.1. Product Overview	14
2.2. SL876Q5-A Block Diagram	15
2.3. SL876Q5-A Module	16
3. SL876Q5-A EVALUATION KIT (EVK)	17
3.1. SL876Q5-A Evaluation Board (EVB)	18
4. PRODUCT FEATURES	19
4.1. Built-in Antenna and Switch	19
4.2. Multi-Constellation Navigation	19
4.3. Quasi-Zenith Satellite System (QZSS) support	19
4.4. Satellite Based Augmentation System (SBAS)	19
4.4.1. SBAS Corrections	19
4.4.2. SBAS Ranging	19
4.5. Assisted GPS (AGPS) - SiRFInstantFix™	19
4.5.1. Client-generated Extended Ephemeris (CGEE)	20
4.5.2. Server-generated Extended Ephemeris (SGEE)	20
4.6. 2-D Positioning	20
4.7. Static Navigation	20
4.8. Velocity Dead-Reckoning	21
4.9. Jamming Rejection – Continuous Wave (CW) Jamming Mitigation	21
4.10. Elevation Mask Angle	21
4.11. 5 Hz Navigation	21
4.12. 10 Hz Navigation	22

4.13.	1PPS	22
4.14.	I/O Communication Ports	22
4.15.	Power Management.....	23
4.15.1.	Full Power Mode	23
4.15.2.	SmartGNSS.....	23
4.15.3.	Trickle Power	24
4.15.4.	Push-to-Fix	24
4.15.5.	SiRFaware.....	24
4.15.6.	Hibernate	24
4.16.	Internal LNA.....	25
4.17.	Device Wake-up (1 st port)	25
4.18.	MEMS Wakeup (2nd Port - I2C).....	25
4.19.	Host I/O Ports	25
5.	PRODUCT PERFORMANCE	26
5.1.	Horizontal Position Accuracy	26
5.2.	Time to First Fix	26
5.3.	Sensitivity	27
6.	SOFTWARE INTERFACE	28
6.1.	NMEA Output Messages	28
6.1.1.	Standard Messages	28
6.1.2.	SiRF Proprietary Messages	29
6.1.3.	Telit Proprietary Messages	29
6.2.	NMEA Input Commands	30
6.2.1.	Change output sentences and their rates.....	30
6.2.2.	Change data rate	30
6.2.3.	Switch to OSP protocol	30
6.3.	OSP Output Messages	30
6.4.	OSP Input Commands.....	30
6.4.1.	Change output messages	30
6.4.2.	Change data rate	30
6.4.3.	Switch to NMEA protocol and data rate.....	30
7.	FLASH UPGRADABILITY.....	31
8.	ELECTRICAL INTERFACE.....	32
8.1.	Module Pin-out.....	32
8.2.	DC Characteristics.....	35
8.3.	Absolute Maximum Ratings	35
8.4.	Power Supply.....	36
8.4.1.	1.8 V Supply Voltage	36
8.4.2.	Voltage Supply Capacitance	36
8.4.3.	DC Power Requirements	36

8.4.4.	DC Power Consumption	37
8.5.	Control Input Signals.....	38
8.5.1.	ON-OFF (input) and SYSTEM-ON (output).....	38
8.5.2.	nReset	38
8.5.3.	Boot Select	39
8.5.4.	Internal / nExternal Antenna Enable.....	39
8.6.	Control Output Signals.....	39
8.6.1.	1PPS	39
8.6.2.	SYSTEM-ON (output)	39
8.6.3.	LNA Enable	39
8.7.	RF Interface.....	40
8.7.1.	Built-in chip antenna	40
8.7.2.	External RF Input.....	40
8.7.3.	Ground Plane.....	40
8.7.4.	External Active Antenna Voltage.....	41
8.7.5.	Burnout Protection	41
8.7.6.	Jamming Rejection	41
8.7.7.	Frequency Plan.....	41
8.7.8.	Local Oscillator Leakage.....	41
8.8.	Host I/O Ports - Configuration and Operation.....	42
8.8.1.	Primary Host Port Configuration.....	42
8.8.2.	Secondary Host Port Configuration.....	42
8.8.3.	UART Operation	42
8.8.4.	I ² C Operation	43
8.8.5.	SPI Operation	44
9.	REFERENCE DESIGN	45
10.	RF FRONT END DESIGN CONSIDERATIONS.....	47
10.1.	RF Signal Requirements.....	47
10.2.	GNSS Antenna Polarization.....	48
10.3.	Active versus Passive Antenna.....	48
10.4.	GNSS Antenna Gain.....	49
10.5.	System Noise Floor.....	49
10.6.	PCB stack and Trace Impedance.....	50
10.7.	RF Trace Losses	50
10.8.	Implications of the Pre-Select SAW Filter.....	51
10.9.	RF Interference.....	51
10.10.	Shielding.....	51
10.11.	Powering an External LNA (External Active Antenna).....	52
11.	MECHANICAL DRAWING	53
12.	PCB FOOTPRINT	54

13.	PRODUCT PACKAGING AND HANDLING	56
13.1.	Product Labelling and Serialization	56
13.1.1.	Product Label – SL876Q5-A	56
13.2.	Product Packaging.....	57
13.3.	Moisture Sensitivity	58
13.4.	ESD Sensitivity	59
13.5.	Reflow.....	59
13.6.	Assembly Considerations.....	59
13.7.	Washing Considerations	59
13.8.	Safety	59
13.9.	Disposal.....	59
14.	ENVIRONMENTAL REQUIREMENTS	60
14.1.	Operating Environmental Limits	60
14.2.	Storage Environmental Limits	60
15.	COMPLIANCES	61
15.1.	EU Declaration of Conformity.....	61
15.2.	RoHS Certificate	61
16.	GLOSSARY AND ACRONYMS	62
17.	SAFETY RECOMMENDATIONS.....	65
17.1.	READ CAREFULLY	65
17.2.	Electrical and Fire Safety.....	66
18.	DOCUMENT HISTORY	67

FIGURES

Figure 2-1 SL876Q5-A Block Diagram	15
Figure 2-2 SL876Q5-A module photo.....	16
Figure 3-1 Evaluation Kit (EVK) contents	17
Figure 3-2 SL876Q5-A Evaluation Board	18
Figure 8-1 SL876Q5-A Pin-out Diagram.....	32
Figure 9-1 Reference Design	45
Figure 10-1 RF Trace Examples	50
Figure 11-1 SL876Q5-A Mechanical Drawing	53
Figure 12-1 SL876Q5-A Footprint and Ground Plane.....	54
Figure 12-2 SL876Q5-A PCB Footprint (detail)	55
Figure 13-1 SL876Q5-A Product Label	56
Figure 13-2 Product Packaging – Tray 90 pcs. each.....	57
Figure 13-3 Moisture-Sensitive Device Label	58

TABLES

Table 4-1 Power Management Modes	23
Table 5-1 SL876Q5-A Horizontal Position Accuracy	26
Table 5-2 SL876Q5-A Time to First Fix.....	26
Table 5-3 SL876Q5-A Sensitivity	27
Table 6-1 Default NMEA Output Messages.....	28
Table 6-2 Available NMEA Output Messages	28
Table 6-3 NMEA Talker IDs	29
Table 8-1 SL876Q5-A Pin-out Function Table.....	34
Table 8-2 DC Characteristics	35
Table 8-3 Absolute Maximum Ratings.....	35
Table 8-4 DC Supply Voltage.....	36
Table 8-5 Power Consumption – SL876Q5-A	37
Table 8-6 Power Consumption – SL876Q5-A Low Power modes	37
Table 8-9 Ground Plane Size	40
Table 8-7 Frequency Plan.....	41
Table 8-8 LO Leakage	41
Table 8-10 Primary Host I/O Port Configuration	42
Table 8-11 UART Pin Assignments.....	43
Table 8-12 I ² C Pin Assignments.....	44
Table 8-13 SPI Mode Pin Assignments.....	44
Table 10-1 Inductor Loss	52
Table 13-1 SL876Q5-A Product Label Description.....	56
Table 14-1 Operating Environmental Limits	60
Table 14-2 Storage Environmental Limits.....	60

1. INTRODUCTION

1.1. Purpose

The purpose of this document is to provide product information for the SL876Q5-A module.

1.2. Contact and Support Information

For general contact, technical support services, technical questions and report documentation errors contact Telit Technical Support at:

- TS-EMEA@telit.com
- TS-AMERICAS@telit.com
- TS-APAC@telit.com

Alternatively, use:

<http://www.telit.com/support>

For detailed information about where you can buy the Telit modules or for recommendations on accessories and components visit:



<http://www.telit.com>

Our aim is to make this guide as helpful as possible. Keep us informed of your comments and suggestions for improvements.

Telit appreciates feedback from the users of our information.

1.3. Text Conventions

- Dates are in ISO 8601 format, i.e. YYYY-MM-DD.

Symbol	Description
	Danger – This information MUST be followed or catastrophic equipment failure and/or bodily injury may occur.
	Caution or Warning – This is an important point about integrating the product into a system. If this information is disregarded, the product or system may malfunction or fail.
	Tip – This is advice or suggestion that may be useful when integrating the product.

1.4. Related Documents

- SL876Q5-A Data Sheet
- SL876Q5-A Evaluation Kit User Guide

1.4.1. Related Documents Requiring a Non-disclosure Agreement

- SiRFstarV B02 Designer's Guide
- SiRFstarV B02 Software User's Guide
- NMEA Reference Guide (CS-129435-MA8)
- SiRFstarV One Socket Protocol Interface Control Document (CS-129291-DCP15)
- SiRFstarV OSP Extensions (CS-303979-7)

2. PRODUCT DESCRIPTION

The SL876Q5-A modules are complete multi-constellation position, velocity, and time (PVT) engines featuring high performance, high sensitivity, and low power consumption.

A built-in tri-band chip antenna receives RF signals from the GNSS satellites. Provision is also made for switching to an external active antenna under host control.

The inclusion of the GLONASS and BeiDou constellations yields better coverage, greater accuracy, and improved availability.

The SL876Q5-A modules are based on the SiRFstar 5e (B02) flash GNSS chip.

2.1. Product Overview

- Complete GNSS receiver module including memory, LNA, TCXO, RTC, and tri-band chip antenna
- External antenna may be used
- Based on the SiRFstar 5e (B02) flash GNSS chip
- GPS (L1), QZSS, and either Glonass (L1) or BeiDou (B1) simultaneous ranging
- Galileo ready
- SBAS capable (WAAS, EGNOS, MSAS, GAGAN), including ranging
- AGPS support for extended ephemeris using local or server-based solutions:
 - Client-Generated Extended Ephemeris (CGEE)
 - Server-Generated Extended Ephemeris (SGEE)
- Jamming Rejection
- Supports an external active antenna
- 1PPS output
- Fix reporting at 1 Hz 5 Hz, or 10 Hz
- NMEA v3.1 command input and data output
- OSP (binary) command input and data output
- Two serial ports for input commands and output messages
- The primary serial port is configurable for UART, I²C, or SPI interface
- The secondary serial port is configurable for UART or I²Cinterface
- 16 Megabit built-in flash memory
- Less than 70 mW typical power consumption (Full Power mode – GPS + GLO)
- Power management modes for extended battery life
 - SiRFSmartGNSS I, SiRFSmartGNSS II
 - Push-to-Fix, Trickle Power, SiRFaware
- Supported by evaluation kits
- -40°C to +85°C industrial temperature range
- 11.0 x 11.9 x 2.15 mm (nominal) 24-pad LCC package
- Surface mountable by standard SMT equipment
- RoHS compliant design

2.2. SL876Q5-A Block Diagram

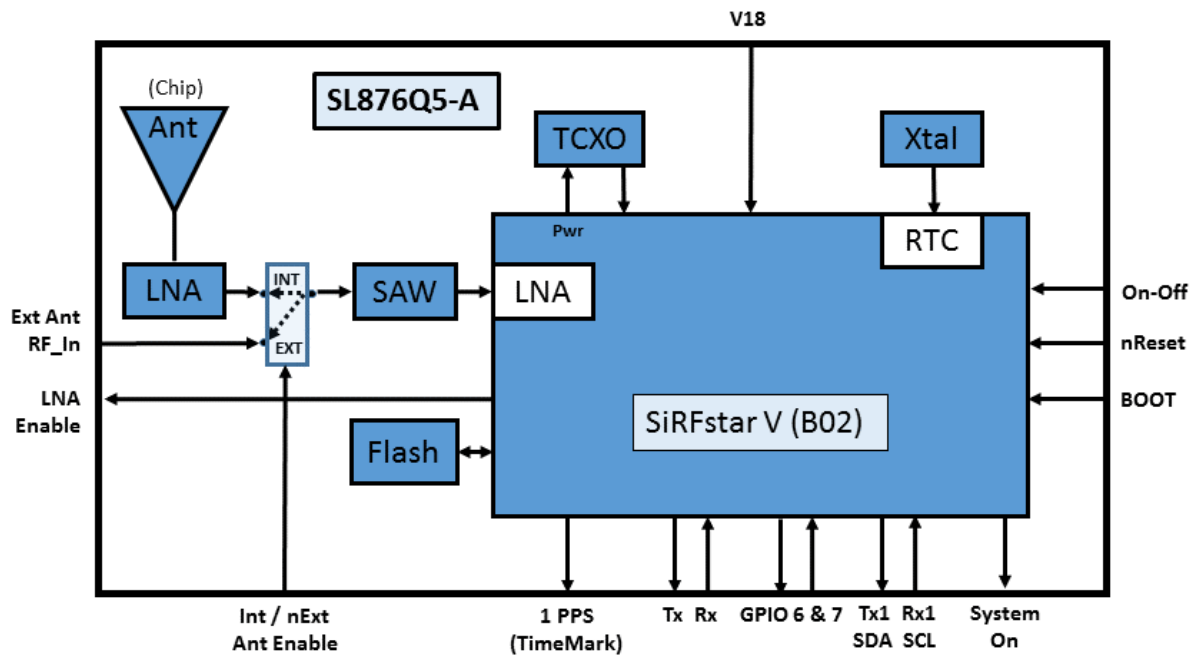

Figure 2-1 SL876Q5-A Block Diagram

2.3. SL876Q5-A Module

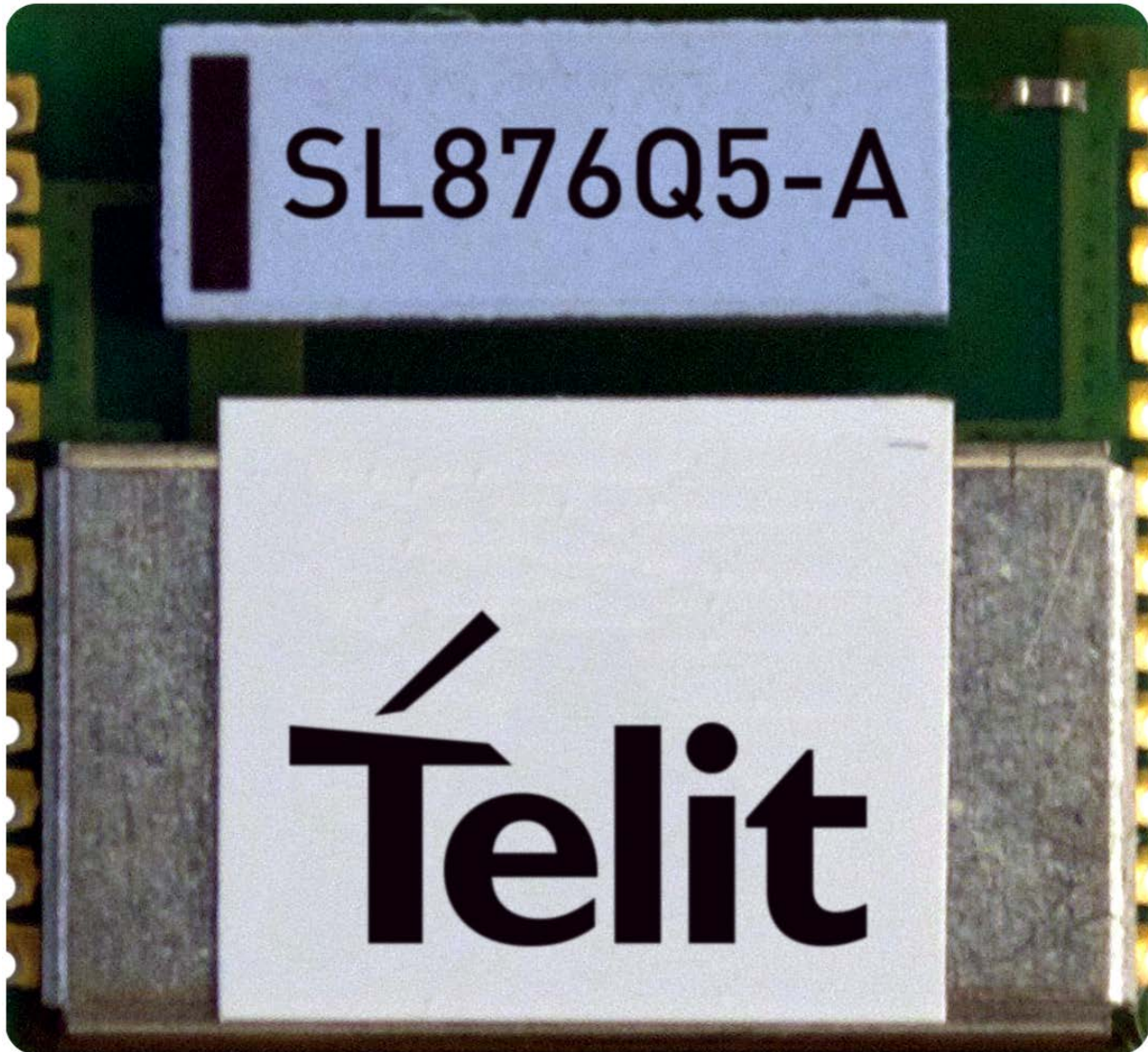

Figure 2-2 SL876Q5-A module photo

3. SL876Q5-A EVALUATION KIT (EVK)



Figure 3-1 Evaluation Kit (EVK) contents

3.1. SL876Q5-A Evaluation Board (EVB)

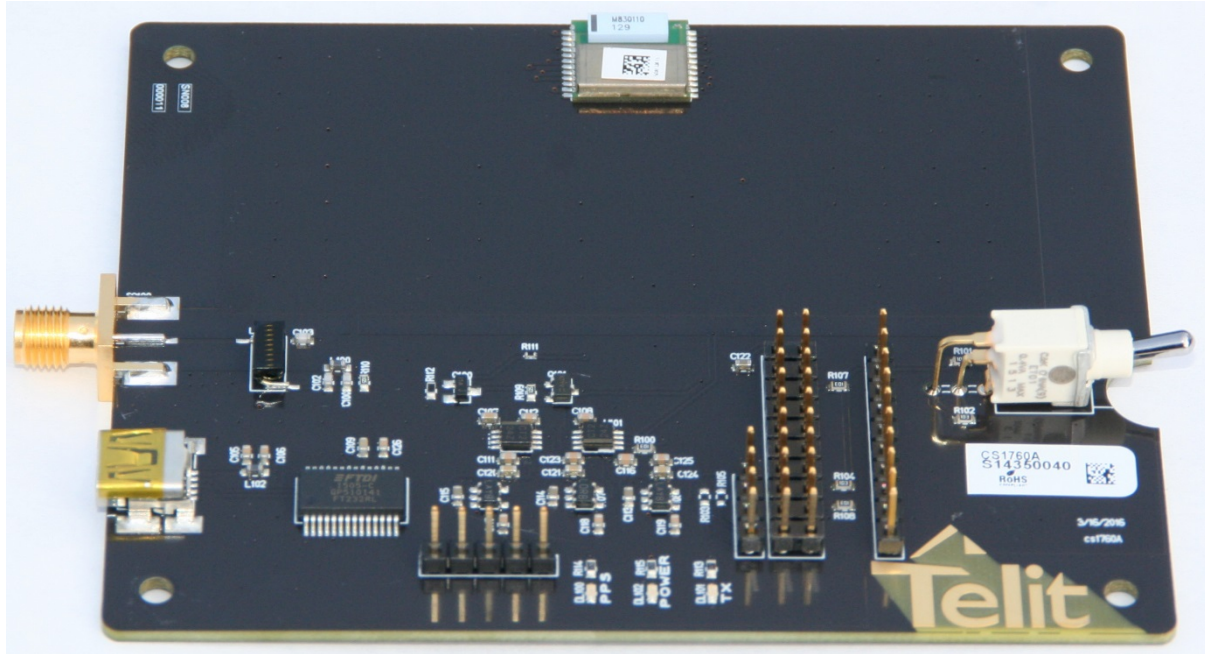

Figure 3-2 SL876Q5-A Evaluation Board

4. PRODUCT FEATURES

4.1. Built-in Antenna and Switch

The module includes a built-in tri-band chip antenna and an RF switch that provides for input from an external active antenna.

4.2. Multi-Constellation Navigation

GPS and GLONASS constellations are enabled by default.

The user may enable or disable GPS, GLONASS, and/or BDS constellations via OSP command MID 222,16. Use of GLONASS or BDS alone may not give optimum positioning results depending on the region that the receiver is located in.

4.3. Quasi-Zenith Satellite System (QZSS) support

The Japanese SBAS satellites are in a highly-inclined elliptical orbit which is geosynchronous (not geostationary) and has analemma-like ground tracks. This orbit allows continuous coverage over Japan using only three satellites. Their primary purpose is to provide augmentation to the GPS system, but the signals may also be used for ranging.

QZSS ranging is disabled by default, but can be enabled via **OSP MID 222,16** command.

4.4. Satellite Based Augmentation System (SBAS)

The receiver is capable of using SBAS satellites both as a source of differential corrections and satellite ranging measurements. These systems (WAAS, EGNOS, GAGAN and MSAS) use geostationary satellites to transmit regional corrections via a GNSS-compatible signal.

4.4.1. SBAS Corrections

The SBAS satellites transmit a set of differential corrections to their respective regions. The use of SBAS corrections can improve positioning accuracy.

SBAS corrections for GPS are disabled by default but can be enabled via **OSP MIDs 133, 138, and 170** commands. Thereafter, the receiver will demodulate and use corrections data from the SBAS signal.

4.4.2. SBAS Ranging

The use of SBAS satellites can augment the number of measurements available for the navigation solution, thus improving availability and accuracy.

SBAS satellite ranging is disabled by default but can be enabled via a \$PSRF103 MNEA command or OSP Mode Control command (**MID 136**).

4.5. Assisted GPS (AGPS) - SiRFInstantFix™

A GNSS receiver requires ephemeris data to calculate the precise position in space of each satellite to be used in the navigation solution. Since the satellites move at a speed of 3874 km/s along their orbits and are subject to gravitational perturbations from all masses in the solar system, this data must be both current and accurate. Each GPS satellite transmits a complete set of its ephemeris coefficients (called the broadcast ephemeris or BE) every 30 seconds. This is therefore the minimum time required for a cold start Time to First Fix (TTFF). The BE data is usually refreshed every 2 hours.

The minimum cold start TTFF can be reduced from 30 seconds to just a few seconds by implementing AGPS, which can provide Extended Ephemeris (EE) data by two methods -

1. Locally-generated: The receiver includes software to project the future positions of the satellites. This data may be calculated out to 14 days or even longer, depending on the resources available in the receiver, e.g. computation ability and memory.
2. Server-generated: A server calculates the future position projections and makes them available to a receiver, typically over the internet. This data may be good for 30 days, depending on available resources, e.g. communication links and storage.

Both CGEE and SGEE are available for GPS and GLONASS satellites.

4.5.1. Client-generated Extended Ephemeris (CGEE)

Extended ephemeris is computed in the receiver and then stored locally in the flash memory.

Whenever the module receives ephemeris data for a satellite, it checks if it has computed CGEE for that satellite recently. If it has not, it computes EE for that satellite (for the next 3 days for GPS and 1 day for GLONASS) and stores it in flash memory. The next time the module turns on and broadcast ephemeris is not available for a visible satellite, the stored CGEE data is searched to see if it is still valid and can be used. If EE data is available for enough satellites, the receiver can obtain a first fix in 10 to 15 seconds (typical) rather than the usual 35 seconds without EE data. CGEE is enabled by default.

4.5.2. Server-generated Extended Ephemeris (SGEE)

Extended ephemeris is computed at the server and saved in a file which can then be downloaded to the receiver's flash memory. The server file contains 1, 3, 7, and 14, days of ephemerides. To use SGEE data, a file must be transferred using NMEA or OSP commands. Please contact Telit support for subscription details.

4.6. 2-D Positioning

By default, the module will compute a 2-D solution if possible when performing initial acquisition. In a 2-D solution, the receiver assumes a value for altitude and uses it to estimate the horizontal position. Under warm and hot start conditions, the receiver uses the last known value of altitude, which is a good assumption in most situations. However under cold start conditions, the last position is unknown, and the receiver assumes a value of 0. In situations where the true altitude is significantly higher than that, the horizontal position estimate will be noticeably impacted. 2_D positioning is controlled by **OSP MID 136**.

4.7. Static Navigation

Static Navigation is an operating mode in which the receiver will freeze the position fix when the speed falls below a set threshold (indicating that the receiver is stationary). The course is also frozen, and the speed is reported as 0. The navigation solution is unfrozen when the speed increases above a threshold or when the computed position exceeds a set distance from the frozen position (indicating that the receiver is again in motion). These thresholds cannot be changed by the user.

This feature is useful for applications in which very low dynamics are not expected, the classic example being an automotive application.

Static Navigation is disabled by default, but can be enabled by **OSP MID 143** command.

4.8. Velocity Dead-Reckoning

Velocity dead-reckoning is the use of the last known velocity to propagate the navigation solution when there are insufficient measurements to calculate an updated solution. It serves to mitigate the effects of blocked satellite signals by continuing to provide a position output.

Note: The receiver outputs status information which indicates that a solution is being maintained using dead-reckoning.

This feature is disabled by default but can be enabled using the Mode Control message (**MID 136**). Valid timeout values are in a range from zero (which disables dead-reckoning) to two minutes.

4.9. Jamming Rejection – Continuous Wave (CW) Jamming Mitigation

Continuous Wave (CW) jamming mitigation improves performance in a system that is affected by these predictable jamming signals:

- Stable jamming signals generated by your system implementation, such as harmonics of digital clocks and logic switching
- Predictable jamming signals in the RF environment (e.g. from collocated transmitters)

When this feature is activated, the process for jamming mitigation is:

1. Detect jamming signals above the noise floor.
2. Isolate and filter frequencies containing jamming signals.

The GNSS signal is constantly monitored for CW jammers and up to eight are detected and cancelled in each band without any operator intervention.

GPS, GLONASS, and BDS band cancellers are activated and reported using OSP Message ID 92. This feature is useful both in the design stage and during the production stage for uncovering issues related to unexpected jamming. Use **OSP MID 220,1** to configure this feature.

4.10. Elevation Mask Angle

The default elevation mask angle is 5° which can be changed using **OSP MID 139**.

4.11. 5 Hz Navigation

When this feature is enabled, the receiver starts in 1 Hz mode and continues until it achieves an over-determined fix with 5 or more satellites. It then computes and outputs solutions 5 times per second. Each computation uses fewer, but more frequent satellite observations. In most situations this gives a better response to vehicle velocity and course changes but might cause slightly more erratic performance in stationary or low-dynamic situations.

The receiver also attempts to send out 5 times as many messages per second. The data rate may need to be increased or the set of scheduled messages be reduced to avoid overloading the available bandwidth.

For NMEA protocol, with default messages set on (GGA, GSA and RMC output once per cycle and GSV output once every 5 cycles) output is nearly 1300 characters per second. Including start and stop bits, at least 19200 bps is required to avoid running out of bandwidth.

For multi-constellation output, one GNGNS and one GNGSA would be added to each report cycle, and three GNGSV sentences every 5th cycle, requiring a minimum of 38,400 bps data rate. For OSP protocol, CSR recommends a minimum data rate of 115200 bps.

To enable 5 Hz Navigation, use a \$PSRF103 command or an **OSP MID 136** command with bit 2 of the pos_mode_enable field set to 1.

4.12. **10 Hz Navigation**

When 10 Hz reporting is commanded, the output report rate is 10 Hz.

4.13. **1PPS**

The module provides a 1PPS timing pulse output. See **Section 8.6.1 1PPS** for details.

4.14. **I/O Communication Ports**

The 1st host port can be configured to communicate using UART, I²C, or SPI interface and supports UART Device Wakeup.

The 2nd host port can be configured for UART or I²C interface and supports I²C MEMS wakeup.

See **section 8.8 Host I/O Ports - Configuration and Operation** for details.

4.15. Power Management

The receiver features several operating modes that provide reduced power consumption.

Availability of GNSS signals in the operational environment will be a factor in choosing power management modes. The designer can choose a mode that provides the best trade-off of navigation performance versus power consumption.

Each of the power management modes can be commanded using the Power Mode Request Message (**MID218,6**). Please refer to the SiRFstarV OSP Extensions manual (CS-303979) for details.

Power Mode	Name	Description
Continuous Fixes	Full Power	Continuous operation in reporting position fixes optimized for the best all-around performance. SmartGNSS modes save power based on satellite signal strength.
	SiRFSmartGNSS 1	
	SiRFSmartGNSS 2	
Periodic Fixes	Trickle Power	Power cycling: RUN - STANDBY
	Push To Fix	Power cycling: RUN - HIBERNATE
	SiRFAware	Periodic data collection & updating
No Fixes	Hibernate	Only RTC and BBRAM are powered up.

Table 4-1 Power Management Modes

4.15.1. Full Power Mode

This mode has the highest average power consumption, but it is the most accurate navigation mode and supports the most dynamic motion scenarios. Full Power is required during initial satellite acquisition, tracking, & navigation and while receiving SGEE assistance data.

4.15.2. SmartGNSS

SmartGNSS modes are power saving alternatives for GNSS operation while maintaining complete functionality of the device similar to full power mode.

The module defaults to full power during the initial acquisition of the first fix, and will continue tracking in SmartGNSS if enabled. Therefore, all first fix metrics for SmartGNSS are equivalent to full power.

4.15.2.1. SmartGNSS I

SmartGNSS I autonomously manage GNSS system usage based on signal conditions to save power. This is the default.

The adaptive mechanism uses fewer system resources during strong signal conditions and uses more resources during weak signal conditions in order to maintain navigation performance. Full constellation tracking is maintained while in this mode. 1PPS is available.

4.15.2.2. SmartGNSS II

SmartGNSS II includes the benefits of SmartGNSS I and achieves further power reduction by minimizing the usage of the secondary GNSS constellation. The adaptive mechanism adjusts constellation usage based on signal conditions to maintain performance while minimizing power consumption. 1PPS is available.

4.15.3. Trickle Power

This mode cycles between FULL POWER and STANDBY states. It provides GPS-only navigation updates at a fixed rate of 1 to 10 seconds, and retains good accuracy and dynamic motion response, but at a lower average power consumption than Full Power. The receiver will go to FULL POWER if signals are weak or the fix is lost. 1PPS is not available. TricklePower mode yields significant power savings in strong signal conditions.

4.15.4. Push-to-Fix

This mode provides for even lower power consumption than TricklePower and is intended for applications that require relatively infrequent position reports. The position is reported periodically (once every 6, 12, 18, 24 seconds or 30 to 86400 seconds in 30 s increments) and also when requested by toggling the On-Off pin.

Push-to-FixII allows vehicle velocity to be taken into account for PTF period, and QoS checks to be enabled or disabled.

4.15.5. SiRFaware

This is a power-saving mode that maintains GPS data by waking up at intervals (e.g. every 30 minutes) to collect signals. Time/and position estimates are updated (e.g. every 10 minutes). Extended Ephemeris will be used if available.

4.15.6. Hibernate

The receiver can be commanded into the HIBERNATE state, which is the lowest power mode available. Only the RTC and BBRAM domains are powered up. Use the **NMEA \$PSRF117,16** or **OSP MID 205** command to transition to this state. The module will also transition to HIBERNATE when the ON-OFF pin is brought low.

4.16. Internal LNA

The module has an adjustable gain LNA internal to the GNSS device.

An additional LNA is in the module circuit for the built-in chip antenna. It is not in the circuit for an external antenna.

Internal antenna LNA power is controlled by the **LNA Enable** output line. This line may also be used to control the external antenna LNA power (when **Internal / nExternal_Ant_Enable** is active).

4.17. Device Wake-up (1st port)

The module will wake up from a commanded HIBERNATE state if the ON_OFF signal remains high and there is data traffic on serial port 0 (first port). The wake-up message will not be acted upon since the receiver is not operating until after wake-up.

See **section 8.8.1 Primary Host Port Configuration** for configuration details.

4.18. MEMS Wakeup (2nd Port - I2C)

If the 2nd port is operating as I²C, the module can configure a Kionix KXCJ9 MEMS accelerometer to generate a signal when a threshold is exceeded. This signal can be connected to a GPIO external interrupt which will cause the module to wake up from a low power state. Use of this feature will require a custom configured firmware build. See **section 8.8.2 Secondary Host Port Configuration** for details. Please contact Telit support for further details.

4.19. Host I/O Ports

The primary host port (TX / RX) can be configured to communicate using UART, I²C, or SPI interface.

The secondary host port (TX1 / RX1) can be configured to communicate using UART or I²C interface.

See **Section 8.8 Host I/O Ports - Configuration and Operation** for details.

5. PRODUCT PERFORMANCE

5.1. Horizontal Position Accuracy

Constellation	CEP (m)
GPS	≤ 1.5
BeiDou	N/A
GPS + Glonass	≤ 1.5
GPS + BeiDou	≤ 2.5
Test Conditions: 24-hr Static, -130 dBm, Full Power mode	

Table 5-1 SL876Q5-A Horizontal Position Accuracy

5.2. Time to First Fix

Constellations(s)	Start Type	Max TTFF (s)
GPS	Hot	≤ 1.1
	Warm - Assisted	7.5
	Warm	22.3
	Cold	31
GPS + GLO	Hot	≤ 1.1
	Warm	22.8
	Cold	27
GPS + BeiDou	Hot	≤ 1.1
	Warm	29.7
	Cold	32.2
Test Conditions: Static scenario, -130 dBm, Full Power mode		

Table 5-2 SL876Q5-A Time to First Fix

5.3. Sensitivity

Constellation(s)	State	Minimum Signal Level (dBm) External Ant
GPS	Acquisition	-148
	Navigation	-161
	Tracking	-165
GPS + GLO	Acquisition	-148
	Navigation	-161
	Tracking	-165
Test conditions: Static scenario, Full Power mode		

Table 5-3 SL876Q5-A Sensitivity

6. SOFTWARE INTERFACE

The host serial I/O port (UART, I²C, or SPI) supports full duplex communication between the receiver and the user.

The default UART configuration is: NMEA, 9600 bps, 8 data bits, no parity, 1 stop bit.

Two protocols are available for command input and data output:

- NMEA-0183 V3.10
- SiRF One Socket Protocol (OSP)

6.1. NMEA Output Messages

Defaults:

- NMEA-0183
- 1 Hz fix rate. Maximum is 10 Hz.

6.1.1. Standard Messages

These messages are sent by default.

Message ID	Description	Frequency
RMC	GNSS Recommended minimum navigation data	1
GGA	GNSS position fix data	1
GSA	GNSS Dilution of Precision (DOP) and active satellites	1
GSV	GNSS satellites in view.	1 / 5
Note: Multiple GSA and GSV messages may be output per cycle.		

Table 6-1 Default NMEA Output Messages

The following messages can be enabled by command:

Message ID	Description
GLL	Geographic Position – Latitude & Longitude
VTG	Course Over Ground & Ground Speed
ZDA	Time and Date
GNS	GNSS Fix Data

Table 6-2 Available NMEA Output Messages

The following Talker IDs are used:

Talker ID	Constellation
GA	Galileo
GB	BeiDou
GL	GLONASS
GP	GPS
GN	Solutions using multiple constellations

Table 6-3 NMEA Talker IDs

6.1.2. SiRF Proprietary Messages

The receiver can issue several proprietary NMEA output messages (\$PSRF) which report additional receiver data and status information.

Some of these messages exceed the 80-character limitation of the NMEA-0183 standard.

6.1.3. Telit Proprietary Messages

6.1.3.1. RF Input Status (Internal vs. External)

To query the status of the RF input, send the command:

\$PTWS,ANT,INPUT,GET*77

A message indicating the RF input source (Internal vs. External Antenna) will be output.

\$PTWS,ANT,INPUT,VAL,INTERNAL,1*AC (default)

or

\$PTWS,ANT,INPUT,VAL,EXTERNAL,0*57

6.2. NMEA Input Commands

The receiver uses NMEA proprietary messages for commands and command responses. This interface provides configuration and control over selected firmware features and operational properties of the module.

The format of a command is:

```
$<command-ID>[,<parameters>]*<cr><lf>
```

Commands are NMEA proprietary format and begin with "\$PSRF".

Parameters, if present, are comma-delimited as specified in the NMEA protocol.

6.2.1. Change output sentences and their rates

Use the Query/Rate Control (\$PSRF103) command to enable and disable output NMEA messages and set their output rates.

6.2.2. Change data rate

Use the Set Serial Port (\$PSRF100) command to change the port data rate.

6.2.3. Switch to OSP protocol

Use the Set Serial Port (\$PSRF100) command to switch to the OSP protocol. It may be necessary to change the data rate since OSP can generate a much larger volume of output per reporting cycle.

6.3. OSP Output Messages

Please refer to SiRF OSP documentation.

6.4. OSP Input Commands

6.4.1. Change output messages

Use **OSP MID 166** to change the output messages.

6.4.2. Change data rate

Use **OSP MID 134** to change the baud rate

6.4.3. Switch to NMEA protocol and data rate

Use the **OSP MID 129** command to switch to the NMEA protocol and change the port data rate.

7. FLASH UPGRADABILITY

The firmware stored in the internal Flash memory of the SL876Q5-A may be upgraded via the serial port TX/RX pads.

Please refer to the **SL876Q5-A Evaluation Kit User Guide** to update the firmware.

8. ELECTRICAL INTERFACE

8.1. Module Pin-out

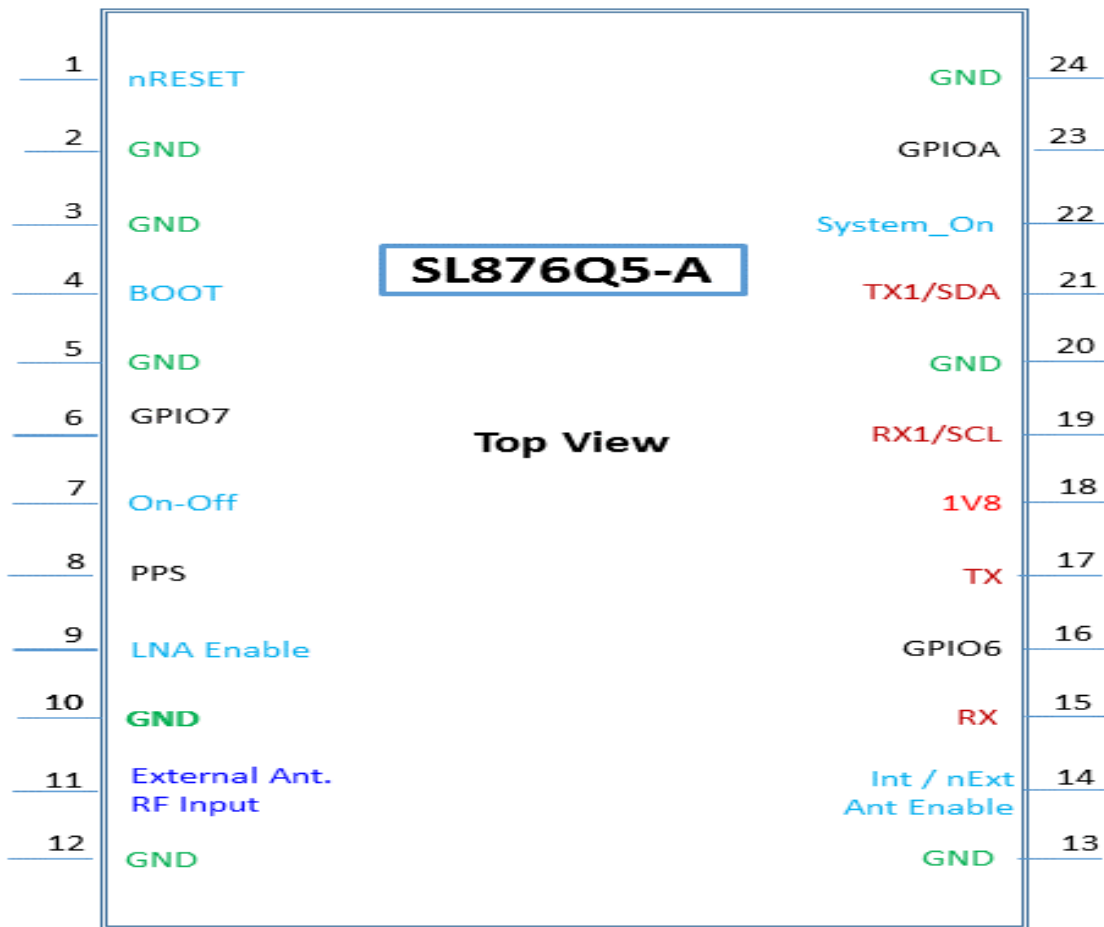

Figure 8-1 SL876Q5-A Pin-out Diagram

Pin	Name	Type	Function
Power			
18	1V8	Pwr	Connect to 1.8 V supply. See Section 8.4 Power Supply .
Ground			
2, 3, 5, 10, 12, 13, 20, 24	GND	Gnd	Connect all pins to ground.
RF Input			
11	Ext Ant RF_In	I	External Antenna RF Input. Max 16V DC may be applied. See Section 8.7 RF Interface .
Control Input			
7	ON-OFF	I	On/Off. See Section 8.5.1 ON-OFF (input) and SYSTEM-ON (output) .
1	nRESET	I	Reset (active low). Do not drive high. See Section 8.5.2 nReset . This signal is not necessary for normal operation and should be brought out to a test point or may be left unconnected.
4	BOOT- Select	I	Low during normal operation. BOOT-SEL may be pulled high to force the module into the programmable state. BOOT-SEL is read prior to the host select lines (GPIO 6 & 7). This pin should be brought out to a test point or left floating. See Section 7 Flash Upgradability .
16	GPIO6	I	GPIOs 6 & 7 are read during power-up and reset to configure the primary host port. After configuration, they may be used for UART or SPI signal lines depending on the firmware options enabled. See Section 8.8 Host I/O Ports - Configuration and Operation .
6	GPIO7		
14	Int / nExt Ant Enable	I	Enable the internal Chip Antenna (and disable the external (active) antenna). Internal pullup. See Section 8.5.4 Internal / nExternal Antenna Enable
Output			
22	System On	O	Indicates the power state of the module. Also called Wakeup . See Section 8.5.1 ON-OFF (input) and SYSTEM-ON (output) .
9	LNA Enable	O	LNA control (used for both internal and external antennas). High when the receiver is operating, low when in a low-power state. Also called GNSS_ON . See Section 4.16 Internal LNA .
8	PPS	O	1PPS time mark. See Section 8.6.1 1PPS .

Primary Host Communications Port I/O.			
See Section 8.8 Host I/O Ports - Configuration and Operation			
17	TX	O	Primary Host Port Output. UART: TX, I ² C: CLK, or SPI: Data Out (MISO).
15	RX	I	Primary Host Port Input. UART: RX, I ² C: DIO, or SPI: Data In (MOSI).
16	GPIO6	I/O	After configuration, may be used for UART: nCTS or SPI: CLK.
6	GPIO7	I/O	After configuration, may be used for UART: nRTS or SPI: nCS.
23	GPIOA		I ² C Data Ready Indicator
Secondary Host Communications Port I/O			
See Section 8.8 Host I/O Ports - Configuration and Operation			
19	SCL / RX1	I/O	Secondary Host Port I/O. UART: Receive (RX1), or I ² C: Clock (SCL)
21	SDA / TX1	I/O	Secondary Host Port I/O. UART: Transmit(TX1), or I ² C: Data (SDA)

Table 8-1 SL876Q5-A Pin-out Function Table

8.2. DC Characteristics

Signal	Description	Min	Typ	Max	Units
V _{OL}	Low level output voltage, I _{OL} 2mA	0.0	-	0.22 x V _{DD}	V
V _{OH}	High level output voltage, I _{OH} 2mA	0.8 * V _{DD}	-	V _{DD}	V
V _{IL}	Low level input voltage	-0.3	-	0.3 x V _{DD}	V
V _{IH}	High level input voltage, I _{IH} 2mA	0.7 x V _{DD}	-	V _{DD} + 0.3	V
R _{PU}	Internal pull-up resistor equivalent	50	86	157	kΩ
R _{PD}	Internal pull-down resistor equivalent	51	91	180	kΩ
L _I	Input leakage at V _I = 1.8 V or 0 V	-10	-	10	μA
L _O	Tristate output leakage at V _O = 1.8 V or 0 V	-10	-	10	μA
C _I	Input capacitance, digital output	-	8	-	pF

Table 8-2 DC Characteristics

8.3. Absolute Maximum Ratings

Parameter	Pins	Absolute Max Rating	Units
RF Input Voltage	All RF inputs	1.5	V
RF Input Power	All RF inputs	10	dBm
ESD Voltage CDM JESD22-C101E	All Pins	± 1100	V
ESD Voltage HDM JEDEC JS-001-2012	All Pins	± 500	V
1.8 V Supply Voltage	1V8	2.2	V
I/O Pin Voltage	All digital inputs	3.60	V

Table 8-3 Absolute Maximum Ratings

8.4. Power Supply

8.4.1. 1.8 V Supply Voltage

Unlike previous GNSS receiver modules, the SL876Q5-A requires a single always-on 1.8 V supply. Rather than having a “split” power supply design of main and backup, the module manages all of its power modes internally. The module will power up into the state determined by the ON-OFF pin (High: RUN; Low: HIBERNATE).

The current power state of the SL876Q5-A can be determined by monitoring the “SYSTEM-ON” signal. A logic low indicates the module is in OFF, RESET, HIBERNATE, or STANDBY; whereas logic high indicates the module is in RUN state.

If the 1.8 volt DC supply is removed from the module (regardless of power state) it will lose current RTC time and the contents of the internal SRAM. To execute an orderly shutdown, place the module into the HIBERNATE state, then remove power. To prevent improper startup, keep the power removed for approximately 10 seconds to reliably clear the SRAM contents.

The module monitors the 1.8 volt supply and issues an internal hardware reset if the supply drops below 1.7 volts. This reset protects the memory from accidental writes during a power down condition. This reset forces the module into a low power stand-by state.

To prevent the reset, the 1.8 volt supply must be regulated to be within ± 50 mV of nominal voltage (including load regulation and power supply noise and ripple). Noise and ripple outside of these limits can affect GNSS sensitivity and also risk tripping the internal voltage supervisors, thereby shutting down the module unexpectedly. Regulators with very good load regulation are strongly recommended along with adequate power supply filtering to prevent power supply glitches as the module transitions between power states.

The power supply voltage, including noise and ripple must be as specified below in **Table 8-4 DC Supply Voltage** for all frequencies. To help meet these requirements, a separate LDO for the module is suggested.

8.4.2. Voltage Supply Capacitance

Aluminum electrolytic capacitors are not recommended at the input to the module due to their high ESR. Tantalum capacitors are recommended with a minimum value of 10uF in parallel with a 0.1uF ceramic capacitor. Ceramic capacitors alone can be used, but ensure that the LDO is stable with such capacitors tied to the output.

8.4.3. DC Power Requirements

Name	Min	Typ	Max	Units
1V8	1.71	1.8	1.89	V
Max ripple: 54 mV (0 to 3 MHz), 15 mV (> 3 MHz)				

Table 8-4 DC Supply Voltage

8.4.4. DC Power Consumption

Power Mode ->	Full Power		Units
	Typ	Max	
State & Constellation			
Acquisition			
GPS only	65	77	mW
GPS and Glonass	84	89	mW
Navigation/Tracking			
GPS Only	53	67	mW
GPS and Glonass	70	80	mW

Table 8-5 Power Consumption – SL876Q5-A

Low Power Modes		
Low Power Mode	Typ	Units
Trickle Power	15	mW
Push to Fix	17	mW
Battery Backup (Hibernate)	68	uW
Trickle Power mode: On 100 ms, Max Off 30 s Push To Fix mode: Interval: 6 s, Max Search: 6 s, Max Off: 120 s		

Table 8-6 Power Consumption – SL876Q5-A Low Power modes

8.5. Control Input Signals

8.5.1. ON-OFF (input) and SYSTEM-ON (output)

The SL876Q5-A module has three power states: OFF, RESET, and ON.

The OFF state is when power is removed from the module.

Upon initial application of power, the module enters the RESET state until the internal reset process is completed. It then transitions to the ON state.

In the ON state, the module will transition to either the RUN or HIBERNATE substate depending on the ON-OFF pin status.

If the ON-OFF pin is high, the module will transition to the RUN substate.

If the ON-OFF pin is low, the module will transition to the HIBERNATE substate.

The ON state is indicated by a logic high output on the SYSTEM-ON signal.

Note: The ON_OFF pin must not be tied to V18 because it must be brought low, then high to transition out of a commanded hibernate state.

The module will transition to the RESET state when external reset (nRESET) is pulled low, or upon internal reset (e.g. supply voltage out of spec). The external nRESET signal takes precedence over the state of the ON-OFF signal. SYSTEM-ON will be logic low.

While in the ON state, there are three substates, depending upon commands or selected power management modes. The three substates are: HIBERNATE, STANDBY, and RUN.

The module transitions between RUN and STANDBY via TricklePower modes; and between RUN and HIBERNATE via PushToFixII and SiRFaware modes. It can also transition from RUN to HIBERNATE by de-asserting the ON-OFF signal. The firmware is configured to transition from HIBERNATE to RUN when data is received on the RX pin.

In HIBERNATE and STANDBY, the SYSTEM-ON signal will be logic low; in RUN, it will be logic high.

To execute an orderly shutdown, place the module in the HIBERNATE substate, then remove power.

Also, see **Section 8.5.2 nReset**.

8.5.2. nReset

The module will generate an internal reset as appropriate. Therefore, no external signal is required for the module to operate properly and this pin may be left unconnected. However, it is desirable to bring it out to a test point if otherwise unconnected.

If an external reset is desired, the signal must be either open collector or open drain without any form of pull up. Do not pull this line high with either a pull up or a driven logic one. When this line is pulled low, the module will immediately transition into reset mode.

When the external reset is released, the module will go through its normal power up sequence provided the V18 supply is within specifications. See **Section 8.5.1 ON-OFF (input) and SYSTEM-ON (output)**.

Pulling nRESET low at any time forces the module into the reset state irrespective of the ON-OFF signal. In the reset state, the SYSTEM-ON signal is low.

Once the nRESET signal is released the module will transition to the HIBERNATE state or to the ON state as determined by the ON-OFF signal input.

8.5.3. **Boot Select**

It is not necessary to use the Boot Select pin to re-flash the receiver since SiRFlive can use commands to perform this task. However, it is desirable to bring it out to a test point if otherwise unconnected.

8.5.4. **Internal / nExternal Antenna Enable**

When high, the module enables RF input from the internal chip antenna and disables input from the external antenna.

When low, the external antenna is enabled and the LNA Enable signal may then be used to control power to the external LNA according to the power state of the receiver (operating or low-power).

This pin has an internal pullup which makes the internal antenna the default RF input.

See **Section 8.6.3 LNA Enable**.

8.6. **Control Output Signals**

8.6.1. **1PPS**

1PPS is a one pulse per second signal which is enabled after the receiver has achieved a 5-satellite Kalman filter position fix. It is disabled when the position fix becomes invalid. However, if Velocity Dead Reckoning is enabled, the pulse is continued until its timeout has expired.

The time mark is within 1 μ s of the GPS epoch and normally within 100 ns.

Pulse width is 250 ms.

8.6.2. **SYSTEM-ON (output)**

See **Section 8.5.1 ON-OFF (input) and SYSTEM-ON (output)**.

8.6.3. **LNA Enable**

This signal indicates the power state of the module. It is high when the receiver is operating and can accept an RF input. When the receiver is in a low-power state, it does not accept RF input, therefore the LNA can be turned off to save power.

This signal controls the internal chip antenna and may also be used to control the external antenna LNA if desired.

8.7. RF Interface

8.7.1. Built-in chip antenna

The SL876Q5-A module includes an internal chip antenna and LNA which is used when the Internal / nExternal_Ant_Enable signal is high. See **Section 8.5.4 Internal / nExternal Antenna Enable**. For important information regarding the required ground plane, see **Section 8.7.3 Ground Plane**

8.7.2. External RF Input

When the **Internal / nExternal_Ant_Enable** signal is low, the RF input (External Antenna RF_In) pin accepts GNSS signals in the range of 1561 MHz to 1606 MHz at a level between -125 dBm and -151 dBm into 50 Ω impedance. See **Section 8.5.4 Internal / nExternal Antenna Enable**.

The LNA_Enable output signal may be used to control power to the External Antenna LNA (when it is selected).



A maximum of 16 V DC can be applied to the RF input.



The RF-IN pin is ESD sensitive.

An active antenna (that is, an antenna with a built in low noise amplifier) with a noise figure of less than 1.0 dB should be used for optimum results. The SL876Q5-A contains an internal pre-select SAW filter which is in both the External and Internal antenna input paths.

The chipset is in the Low Gain configuration by default. This is the correct choice for the internal chip antenna and an external active antenna. Using an external passive antenna (which is not recommended) would require changing the gain to High via an OSP command.

8.7.3. Ground Plane

Due to the very small size of the built-in chip antenna, a proper ground plane is critical to achieving good performance. Please refer to **Figure 12-1 SL876Q5-A Footprint and Ground Plane** for ground plane requirements.

The recommended minimum size is 40 mm x 80 mm. Using a smaller size ground plane will result in significant performance degradation. Please note that the guideline values in the table below are only a very rough approximation since there are many variables that affect the results.

Ground Plane Performance Reduction (approximate)	
Size	Signal Strength (relative) dB
40 mm x 80 mm	-0
40 mm x 60 mm	-5
40 mm x 40 mm	-7
40 mm x 20 mm	-10

Table 8-7 Ground Plane Size

8.7.4. External Active Antenna Voltage

An external bias-T is required to provide voltage to an external antenna. A maximum of 16 V DC may be applied to the External Ant. RF_In pin. See **Section 10.11 Powering an External LNA (External Active Antenna)**.

8.7.5. Burnout Protection

The receiver can accept an external RF signal of up to -20 dBm with a DC voltage of ± 15 V without risk of damage.

8.7.6. Jamming Rejection

Jamming Rejection can be used for solving narrow band (CW) EMI problems in the customer's system. It is effective against narrow band clock harmonics. Jamming Rejection is not effective against wide band noise, e.g. from a host CPU memory bus or switching power supply because these sources typically cannot be distinguished from thermal noise. A wide band jamming signal effectively increases the noise floor and reduces GNSS signal levels.

Please refer to **Section 4.9 Jamming Rejection – Continuous Wave (CW) Jamming Mitigation** for further details.

8.7.7. Frequency Plan

Signal	Frequency (MHz)
TCXO Frequency	26.000
LO Frequency	1588.6

Table 8-8 Frequency Plan

8.7.8. Local Oscillator Leakage

Signal	Level
LO Leakage	-70 dBm (typical)

Table 8-9 LO Leakage

8.8. Host I/O Ports - Configuration and Operation

The module host serial ports are configurable for the desired interface.

The primary host port can be configured to communicate using a UART, I²C, or SPI interface. See **Section 8.8.1 Primary Host Port Configuration** for details of port configuration.

Also, see **Section 4.17 Device Wake-up** for this port.

Default port configuration is UART, NMEA at 9600 bps, 8-bit, No parity, and 1 stop bit.

The secondary host port can be configured to communicate using a UART or I²C interface. SPI is not available because it requires 4 pins.

8.8.1. Primary Host Port Configuration

The module includes a full-duplex serial interface which is configured for UART, I²C or SPI interface by reading GPIO6 and GPIO7 pins at startup or reset (only).

The following table gives the required input signals:

Pin	Pullup / Pulldown	UART	I ² C (multi-master)	SPI (slave)
GPIO6	Weak internal pulldown	Pullup 10 k Ω to +1.8 V (may become CTS)	Float	Float (becomes SCLK)
GPIO7	Weak internal pullup	Float (may become RTS)	Pulldown 10 k Ω to ground	Float (becomes SPI_CS)

Table 8-10 Primary Host I/O Port Configuration

Note: The GPIO6 and GPIO7 lines are read for configuration purposes at power up or reset only. Afterwards, they may be used for UART or SPI signal lines depending on firmware options.

8.8.2. Secondary Host Port Configuration

The secondary Port is configured by loading the desired FW build.

8.8.3. UART Operation

Upon power up, the module will communicate using a standard asynchronous 8 bit protocol with output messages appearing on the TX line and input commands and data being received on the RX line. The UART can operate at baud rates from 4800 bps to 1.2288 Mbps, however speeds above 115,200 bps have not been fully tested and verified.

If the module is operated in TricklePower mode, a baud rate of at least 38,400 is recommended. This reduces the time required to empty the output buffer and allows the receiver to drop into the low power state for a longer period of time.

The minimum recommended baud rate for OSP is 38400, or 115200 if debug data messages are enabled.

Use the Query/Rate Control (**PSRF103**) to enable and disable output NMEA messages and set their output rates.

After configuration, the pins are defined below:

Pin Name	UART Function
Primary Port	
TX	Transmit Data (TX)
RX	Receive Data (RX)
GPIO6	nCTS
GPIO7	nRTS
Secondary Port	
TX1	Transmit Data (TX1)
RX1	Receive Data (RX1)

Table 8-11 UART Pin Assignments

Note: Flow control is disabled by default.

Use the **OSP MID 178,70** command to enable/disable flow control on the first port.

8.8.4. I²C Operation

See **Section 8.8.1 Primary Host Port Configuration** to specify I²C interface. Upon power up, the module acts as a master transmitter and a slave receiver (multi-master mode).



When used in I²C mode, pull-ups in the range of 1K to 2.2K to a 1.8V to 3.6V power supply are required on the RX and TX lines.

Clock rates of 100 and 400 kbps are supported.

The operation of the I²C with a master transmit and slave receive resembles a UART operation, where both the module and the host can independently freely transmit. It is possible to enable the master transmit and slave receive at the same time, as the I²C bus allows for contention resolution between module and host vying for the bus.

After configuration, the pins are defined below:

Pin Name	I ² C Function
Primary Port	
TX	I ² C Clock (SCL)
RX	I ² C Data (SDA)
GPIO6	Not used
GPIO7	Not used
GPIOA	Data Ready
Secondary Port	
TX1	I ² C Data (SDA)
RX1	I ² C Clock (SCL)

Table 8-12 I²C Pin Assignments

8.8.5. SPI Operation

See **Section 8.8.1 Primary Host Port Configuration** to specify SPI interface.

The 2nd port cannot be configured for SPI interface since there are only two pins available.

SPI is supported in the slave mode. The MicroWire format is not supported.

Maximum speed is 6.8 MHz.

After configuration, the pins are defined below:

Pin Name	SPI Function
Primary Port	
TX	SPI Data Out (MISO)
RX	SPI Data In (MOSI)
GPIO6	SPI Clock (SCLK)
GPIO7	SPI Chip Select (CS#)
Secondary Port	
Not Available	

Table 8-13 SPI Mode Pin Assignments

9. REFERENCE DESIGN

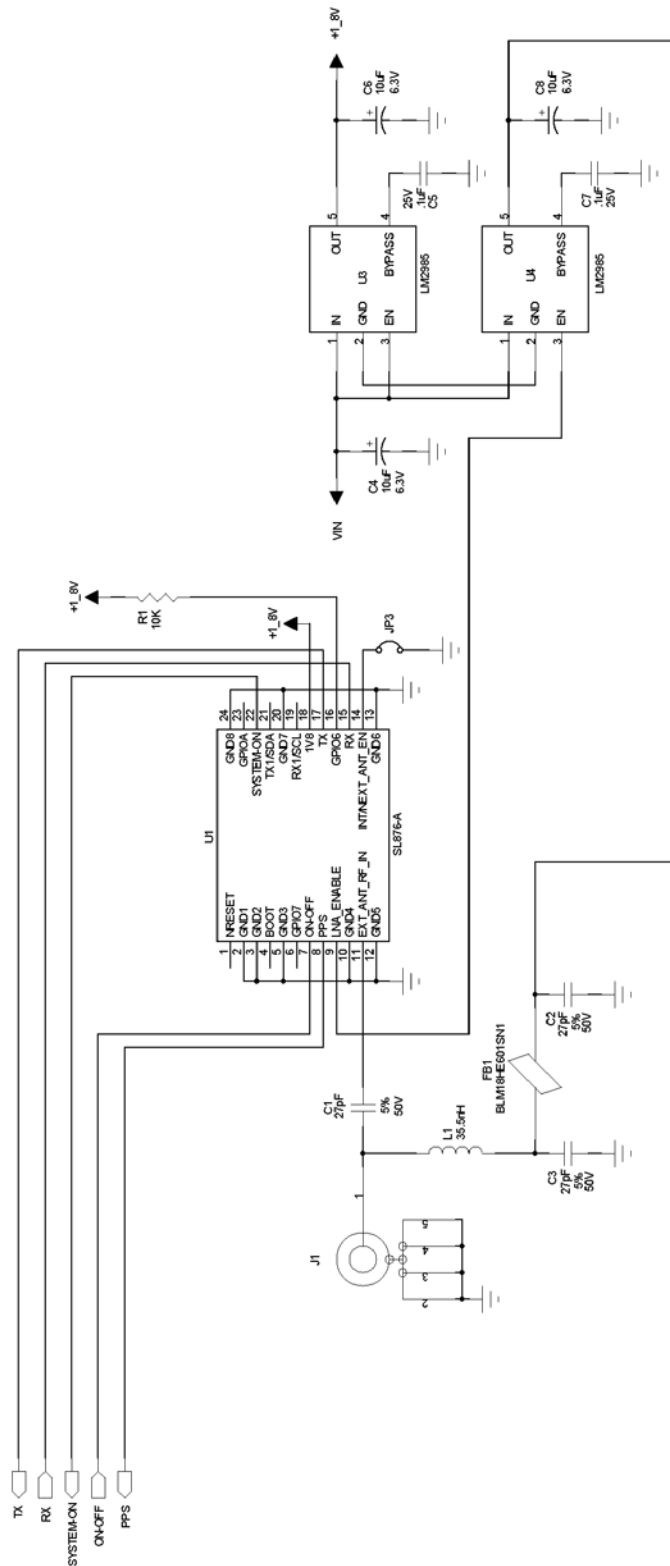

Figure 9-1 Reference Design



Please refer to **Section 8 Electrical Interface** for important details for each pin.

Along with power and ground, the signals required to operate the module properly are: an external antenna RF input (optional), a UART TX/RX pair, and several control lines as described below.

The power supply must have tight voltage regulation under varying line and load conditions to prevent falsely tripping the internal voltage supervisor within the module. See **Section 8.4 Power Supply** for details of requirements for the power supply.

Due to the very small size of the built-in chip antenna, a proper ground plane is critical to achieving good performance. Please refer to **Figure 12-1 SL876Q5-A Ground Plane** for requirements.

An optional active GNSS antenna can be connected through C1 (which is used to block DC voltage) to the External_Ant_RF_Input pin. The reference design shows a DC power feed for the external antenna's LNA which is controlled by the state of the module (operating vs. low power) on the LNA_ENABLE pin. The inductor L1 is chosen to be self-resonant at the GPS L1 frequency (1.57542 GHz) to minimize loading on the RF trace. Capacitor C3 is also chosen to be self-resonant to provide a near short at that RF frequency. The internal chip antenna is enabled by grounding the INT/nEXT_Ant_En pin through JP3.

The TX/RX serial port can be configured for UART, I²C, or SPI interface using GPIO 6 and 7. As shown, GPIO7 is floating and resistor R4 pulls GPIO6 high, which specifies the host port configuration to be UART. See **Section 8.8 Host I/O Ports - Configuration and Operation** for details.

TX and RX are a standard serial UART port with a default bit rate of 9600 bps, 8 data bits, 1 stop bit, and no parity. As is the case with all UART data, the idle state is logic one. TX is a 1.8 V logic level signal. RX is tolerant to 3.6 VDC.

ON-OFF is an input to control the power state of the module. After power-up, the module will enter the RUN state if it is high, or the HIBERNATE state if it is low. The SYSTEM-ON output pin indicates the system's state.

Note: ON-OFF must not be tied to 1V8 or the module will not be able to exit a commanded HIBERNATE state.

nRESET (active low) will cause the module to be reset and then resume operation when released. It is desirable to bring this pin out to a test point if not otherwise connected.

BOOT is used to configure the boot source. It is desirable to bring this pin out to a test point.

SYSTEM-ON is a 1.8V output indicating the power state of the module. If the module is in the RUN state, the logic level will be high, otherwise the logic level will be low.

PPS is a one pulse per second time mark output pulse. It may be left unconnected.

10. RF FRONT END DESIGN CONSIDERATIONS

10.1. RF Signal Requirements

The receiver can achieve Cold Start acquisition with a signal level above the specified minimum at its input. This means that it can acquire and track visible satellites, download the necessary ephemeris data and compute the location within a 5 minute period. In the GNSS signal acquisition process, decoding the navigation message data is the most difficult task, which is why Cold Start acquisition requires a higher signal level than navigation or tracking. For the purposes of this discussion, autonomous operation is assumed, which makes the Cold Start acquisition level the dominant design constraint. If assistance data in the form of time or ephemeris aiding is available, lower signal levels can be used for acquisition.

The GPS signal is defined by IS-GPS-200. This document states that the signal level received by a linearly polarized antenna having 3 dBi gain will be a minimum of -130 dBm when the antenna is in the worst-case orientation and the satellite is 5 degrees or more above the horizon.

In actual practice, the GPS satellites transmit slightly more power than specified by IS-GPS-200, and the signal level typically increases if a satellite has higher elevation angles.

The GLONASS signal is defined by GLONASS ICD 2008 Version 5.1. This document states that the power level of the received RF signal from GLONASS satellite at the output of a 3dBi linearly polarized antenna is not less than -131dBm for L1 sub-band provided that the satellite is observed at an angle 5 degrees or more above the horizon.

The receiver will display a reported C/No of 40 dB-Hz for a GPS signal level of -130 dBm at the RF input. This assumes a SEN (system equivalent noise) of the receiver of 4dB. System Equivalent Noise includes the Noise Figure of the receiver plus signal processing or digital noise. For an equivalent GLONASS signal level the GLONASS signal will report a C/No of approximately 39 dB-Hz. This is due to the receiver's higher losses (NF) for GLONASS signals and a higher signal processing noise for GLONASS signals.

Each GNSS satellite presents its own signal to the receiver, and best performance is obtained when the signal levels are between -130 dBm and -125 dBm. These received signal levels are determined by:

- GNSS satellite transmit power
- GNSS satellite elevation angle
- Free space path loss
- Extraneous path loss (such as rain)
- Partial or total path blockage (such as foliage or buildings)
- Multipath interference (caused by signal reflection)
- GNSS antenna characteristics
- Signal path after the GNSS antenna

The satellite transmit power is specified in each constellation's reference documentation, readily available online.

The GNSS signal is relatively immune to attenuation from rainfall.

However, the GNSS signal is heavily influenced by attenuation due to foliage (such as tree canopies, etc.) as well as outright blockage caused by buildings, terrain or other items near the line of sight to the specific GNSS satellite. This variable attenuation is highly dependent upon satellite location. If enough satellites are blocked, say at a lower elevation, or all in one

general direction, the geometry of the remaining satellites will result in a lower position accuracy. The receiver reports this geometry effect in the form of PDOP, HDOP and VDOP numbers.

For example, in a vehicular application, the GNSS antenna may be placed on the dashboard or rear package tray of an automobile. The metal roof of the vehicle will cause significant blockage, plus any thermal coating applied to the vehicle glass can attenuate the GNSS signal by as much as 15 dB. Again, both of these factors will affect the performance of the receiver.

Multipath interference is a phenomenon where the signal from a particular satellite is reflected and is received by the GNSS antenna in addition to or in place of the line of sight signal. The reflected signal has a path length that is longer than the line of sight path and can either attenuate the original signal, or, if received in place of the original signal, can add error in determining a solution because the distance to the particular satellite is actually shorter than measured. It is this phenomenon that makes GNSS navigation in urban canyons (narrow roads surrounded by high rise buildings) so challenging. In general, the reflection of a GNSS signal causes the polarization to reverse. The implications of this are covered in the next section.

10.2. GNSS Antenna Polarization

The GPS broadcast signal is Right Hand Circularly Polarized (RHCP).

An RHCP antenna will have 3 dB gain compared to a linearly-polarized antenna (assuming the same antenna gain specified in dBic and dBi respectively).

An RHCP antenna is better at rejecting multipath interference than a linearly polarized antenna because the reflected signal changes polarization to LHCP. This signal would be rejected by the RHCP antenna, typically by 20 dB or greater.

If the multipath signal is attenuating the line of sight signal, then the RHCP antenna would show a higher signal level than a linearly polarized antenna because the interfering signal is rejected.

However, in the case where the multipath signal is replacing the line of sight signal, such as in an urban canyon environment, then the number of satellites in view could drop below the minimum needed to determine a 3D position. This is a case where a bad signal may be better than no signal. The system designer needs to understand trade-offs in their application to determine the better choice.

10.3. Active versus Passive Antenna

If the GNSS antenna is placed near the receiver and the RF trace losses are not excessive (nominally 1 dB), then a passive antenna may be used. This would often be the lowest cost option and most of the time the simplest to use. However, if the antenna needs to be located away from the receiver, then an active antenna may be required to obtain the best system performance. An active antenna includes a built-in low noise amplifier (LNA) to overcome RF trace and cable losses. Also, many active antennas have a pre-select filter, a post-select filter, or both.

Important specifications for an active antenna LNA are gain and noise figure.

10.4. GNSS Antenna Gain

Antenna gain is defined as the amplified signal power from the antenna compared to a theoretical isotropic antenna (equally sensitive in all directions).

Optimum performance is realized only if the firmware build and hardware configuration match the type of antenna used (active or passive). The firmware must set the internal LNA gain to correspond to the installed antenna.

For example, a 25 mm by 25 mm square patch antenna on a reference ground plane (usually 70 mm by 70 mm) may give an antenna gain at zenith of 5 dBic. A smaller 18 mm by 18 mm square patch on a reference ground plane (usually 50 mm by 50 mm) may give an antenna gain at zenith of 2 dBic.

An antenna vendor should specify a nominal antenna gain (usually at zenith, or directly overhead) and antenna pattern curves specifying gain as a function of elevation, and gain at a fixed elevation as a function of azimuth. Pay careful attention to the requirement to meet the required design, such as ground plane size and any external matching components. Failure to follow these requirements could result in very poor antenna performance.

It is important to note that GNSS antenna gain is not the same as external LNA gain. Most antenna vendors will specify these numbers separately, but some combine them into a single number. Both numbers are significant when designing the front end of a GNSS receiver.

For example, antenna X has an antenna gain of 5 dBic at azimuth and an LNA gain of 20 dB for a combined total of 25 dB. Antenna Y has an antenna gain of -5 dBic at azimuth and an LNA gain of 30 dB for a combined total of 25 dB. However, in the system, antenna X will outperform antenna Y by about 10 dB (Refer to **Section 4.16 Internal LNA** for more details on external LNA gain).

An antenna with higher gain will generally outperform an antenna with lower gain. However, once the signals are above about -130 dBm for a particular satellite, no improvement in performance would be realized. But for those satellites with a signal level below about -135 dBm, a higher gain antenna would amplify the signal and improve the performance of the GNSS receiver. In the case of really weak signals, a good antenna could mean the difference between being able to use a particular satellite signal or not.

10.5. System Noise Floor

The receiver will display a reported C/No of 40 dB-Hz for an input signal level of -130 dBm. The C/No number means the carrier (or signal) is 40 dB greater than the noise floor measured in a one Hz bandwidth. This is a standard method of measuring GNSS receiver performance.

The simplified formula is:

$$C/No = \text{GNSS Signal level} - \text{Thermal Noise} - \text{System NF}$$

Equation 10-1 Carrier to Noise Ratio

Thermal noise is -174 dBm/Hz at 290K.

We can estimate a system noise figure of 4 dB for the module, consisting of the pre-select SAW filter loss, the LNA noise figure, and implementation losses within the digital signal processing unit. The DSP noise is typically 1.0 to 1.5 dB.

However, if a good quality external LNA is used, the noise figure of that LNA (typically better than 1dB) could reduce the overall system noise figure from 4 dB to approximately 2 dB.

10.6. PCB stack and Trace Impedance

It is important to maintain a 50 Ω impedance on the RF path trace. Design software for calculating trace impedance can be found from multiple sources on the internet. The best method is to contact your PCB supplier and request a stackup for a 50 Ω controlled impedance board. They will give you a suggested trace width along with PCB stackup needed to create the 50 Ω impedance.

It is also important to consider the effects of component pads that are in the path of the 50 Ω trace. If the traces are shorter than a 1/16th wavelength, transmission line effects will be minimized, but stray capacitance from large component pads can induce additional RF losses. It may be necessary to ask the PCB vendor to generate a new PCB stackup and suggested trace width that is closer to the component pads, or modify the component pads themselves

10.7. RF Trace Losses

RF Trace losses on a PCB are difficult to estimate without having appropriate tables or RF simulation software. A good rule of thumb would be to keep the RF traces as short as possible, make sure they are 50 ohm impedance, and don't contain any sharp bends.

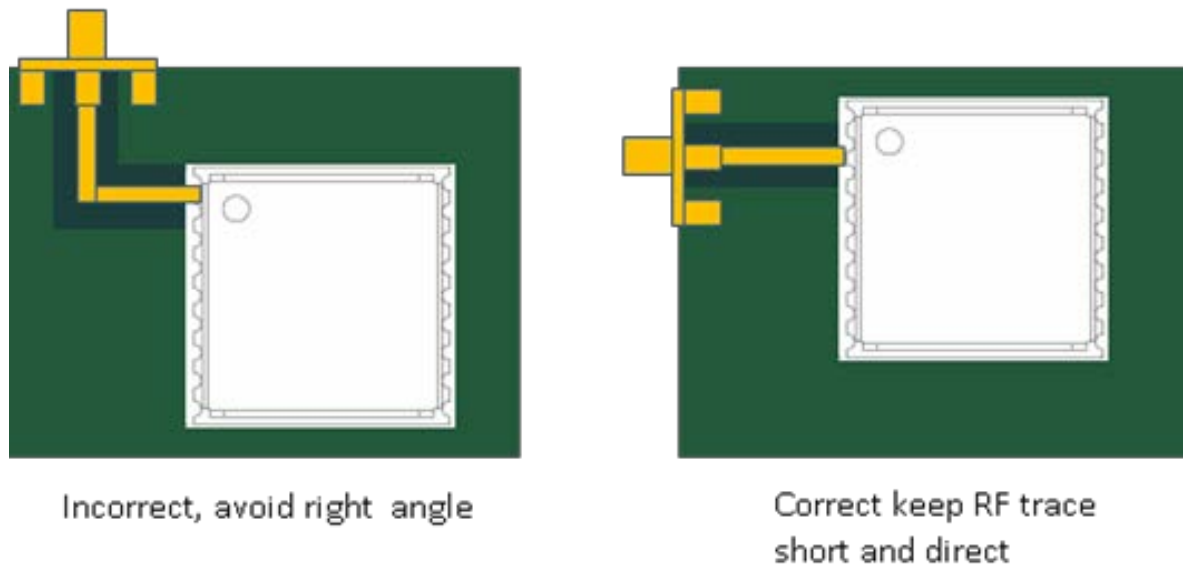

Figure 10-1 RF Trace Examples

10.8. Implications of the Pre-Select SAW Filter

The RF input of the module is connected directly to the SAW filter (after the RF switch). Therefore, any circuit connected to the RF input pin would see a complex impedance presented by the SAW filter (especially out of band), rather than the relatively broad and flat return loss presented by an LNA. Filter devices pass the desired in-band signal, resulting in low reflected energy (good return loss), and reject the out-of-band signals by reflecting it back to the input, resulting in bad return loss.

If an external amplifier is to be used with the receiver, the overall design should be checked for RF stability to prevent the external amplifier from oscillating. Amplifiers that are unconditionally stable at their output will function correctly.

If an external filter is to be connected directly to the module, care needs to be used in making sure the external filter or the internal SAW filter performance is not compromised. These components are typically specified to operate into 50 Ω impedance, which is generally true in-band, but would not be true out of band. If there is extra gain associated with the external filter, then a 6 dB Pi or T resistive attenuator is suggested to improve the impedance match between the two components.

10.9. RF Interference

RF interference into the GNSS receiver tends to be the biggest problem when determining why the system performance is not meeting expectations. As mentioned earlier, the GNSS signals are at -130 dBm and lower. If signals higher than this are presented to the receiver, the RF front end can be overdriven. The receiver can reject CW jamming signals in each band (GPS, GLONASS, and BeiDou), but would still be affected by non-CW signals.

The most common source of interference is digital noise, often created by the fast rise and fall times and high clock speeds of modern digital circuitry. For example, a popular netbook computer uses an Atom processor clocked at 1.6 GHz. This is only 25 MHz away from the GNSS signal, and depending upon temperature of the SAW filter, can be within its passband. Because of the nature of the address and data lines, this would be broadband digital noise at a relatively high level.

Such devices are required to adhere to a regulatory standard for emissions such as FCC Part 15 Subpart J Class B or CISPR 22. However, these regulatory emission levels are far higher than the GNSS signal.

10.10. Shielding

Shielding the RF circuitry generally is ineffective because the interference is received by the GNSS antenna itself, the most sensitive portion of the RF path. The antenna cannot be shielded because it could not then receive the GNSS signals.

There are two solutions, one is to move the antenna away from the source of interference, and the other is to shield the digital interference source to prevent it from getting to the antenna.

10.11. Powering an External LNA (External Active Antenna)

An external LNA requires a source of power. Many active antennas accept 3 V to 5 V DC that is impressed upon the RF signal line.

Two approaches can be used:

1. Use an inductor to tie directly to the RF trace. This inductor should be at self-resonant at L1 (1.57542 GHz) and should have good Q for low loss. The higher the inductor Q, the lower the loss will be. The side of the inductor connecting to the antenna supply voltage should be bypassed to ground with a good quality RF capacitor, again with self-resonance at the L1 frequency.
2. Use a quarter wave stub in place of the inductor. The length of the stub is designed to be exactly $\frac{1}{4}$ wavelength at L1, which has the effect of making an RF short at one end of the stub to appear as an RF open at the other end. The RF short is created by a high quality RF capacitor operating at self-resonance.

The choice between the two would be determined by:

- RF path loss introduced by either the inductor or quarter wave stub.
- Cost of the inductor.
- Space availability for the quarter wave stub.
-

Simulations done by Telit show the following losses:

Inductor	Additional signal loss (dB)
Murata LQG15HS27NJ02	0.65
Quarter wave stub on FR4	0.59
Coilcraft B09TJLC (used in ref. design)	0.37

Table 10-1 Inductor Loss

Since this additional loss occurs after the LNA, it is generally not significant unless the circuit is being designed to work with both active and passive antennas.

11. MECHANICAL DRAWING

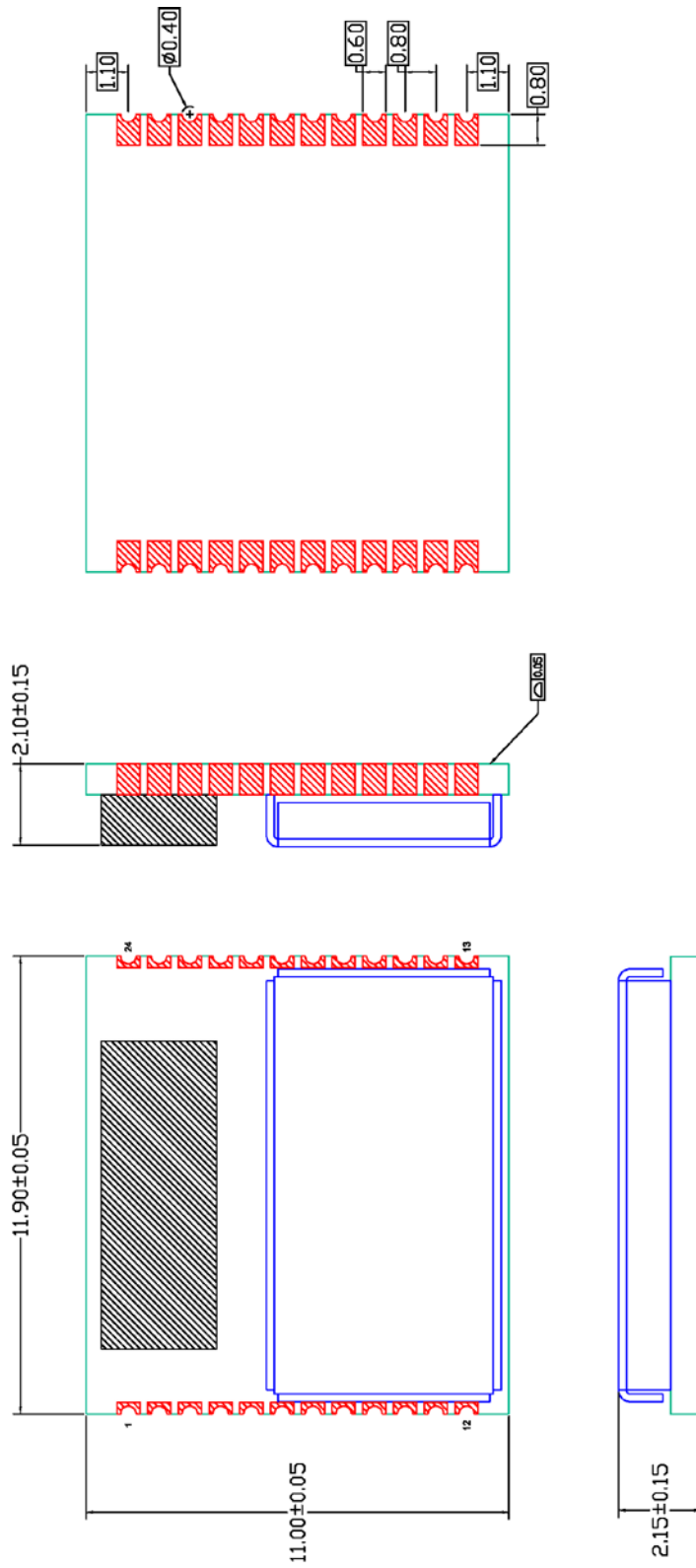

Figure 11-1 SL876Q5-A Mechanical Drawing

12. PCB FOOTPRINT

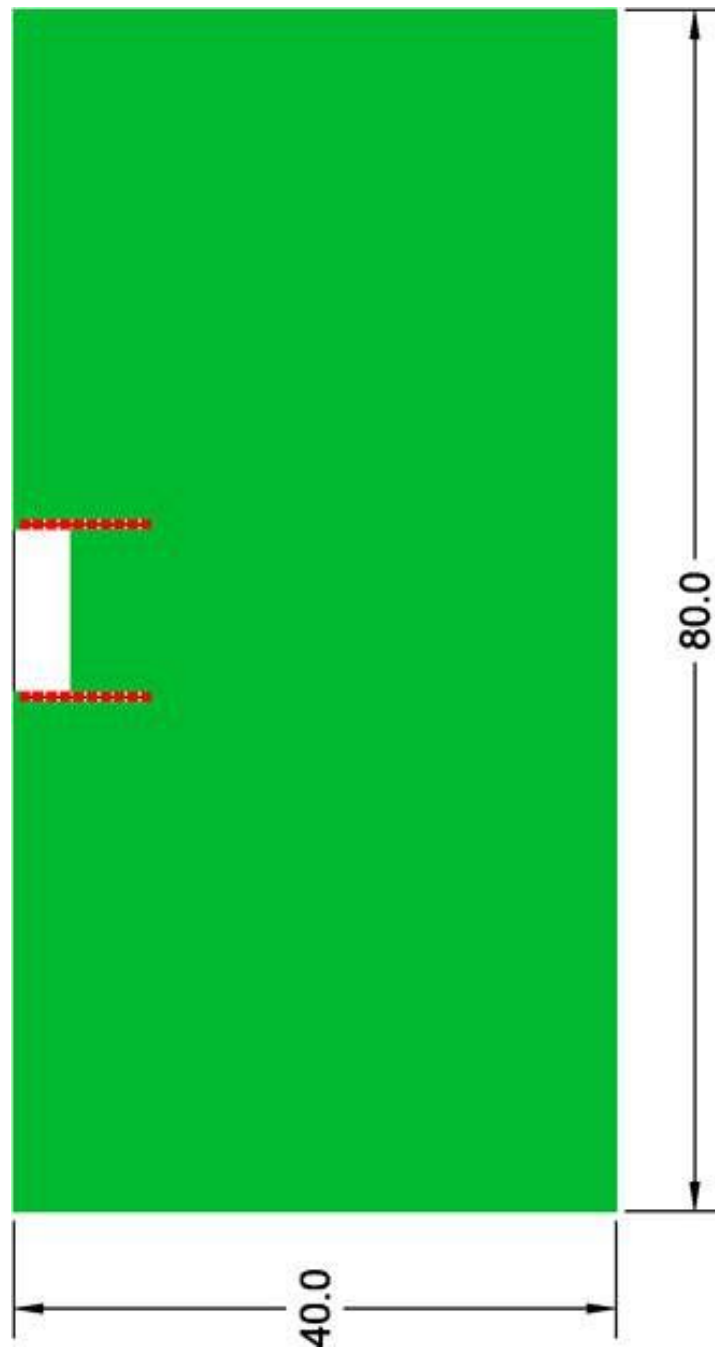

Figure 12-1 SL876Q5-A Footprint and Ground Plane

The SL876-A requires a reference ground plane of 40mm by 80mm for the chip antenna to work properly. The SL876-A is centered on the long axis, but flush with the top edge of the reference ground plane (shown to the left here).

The keepout area underneath the module must extend to all layers of the host PCB.

All dimensions are in mm.

See the detail drawing on the next page.

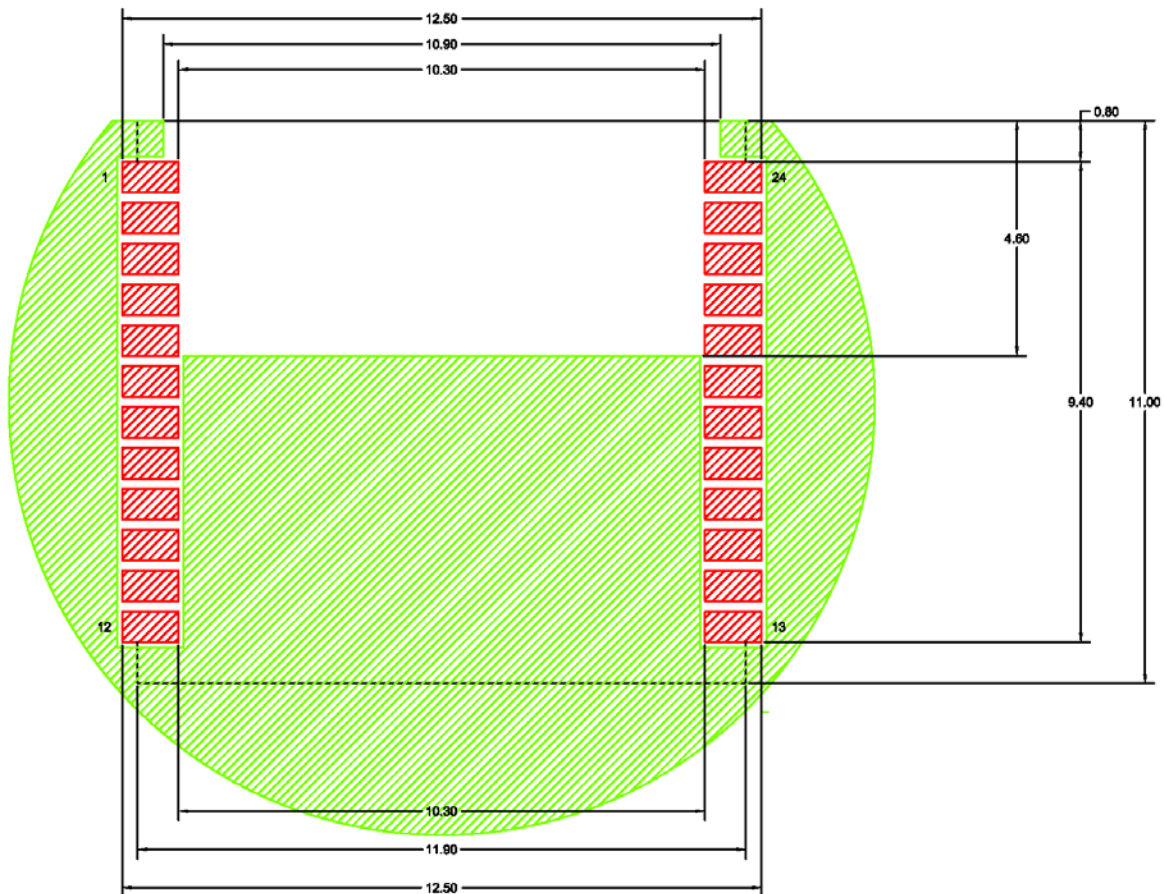

Figure 12-2 SL876Q5-A PCB Footprint (detail)

The SL876-A requires a reference ground plane of 40mm by 80mm for the chip antenna to work properly. The SL876-A is centered on the long axis, but flush with the top edge of the reference ground plane (shown to the left here).

This drawing identifies the dimensions for the user's PCB for the SL876-A pads (red) and the ground plane (green).

The keepout area underneath the module must extend to all layers of the host PCB.

All dimensions are in mm.

Please refer to **Section 8.7.3 Ground Plane** for further information.

13. PRODUCT PACKAGING AND HANDLING

13.1. Product Labelling and Serialization

The SL876Q5-A module label has a 2D Barcode with the module serial number. Contact a Telit representative for information on specific module serial numbers.

13.1.1. Product Label – SL876Q5-A

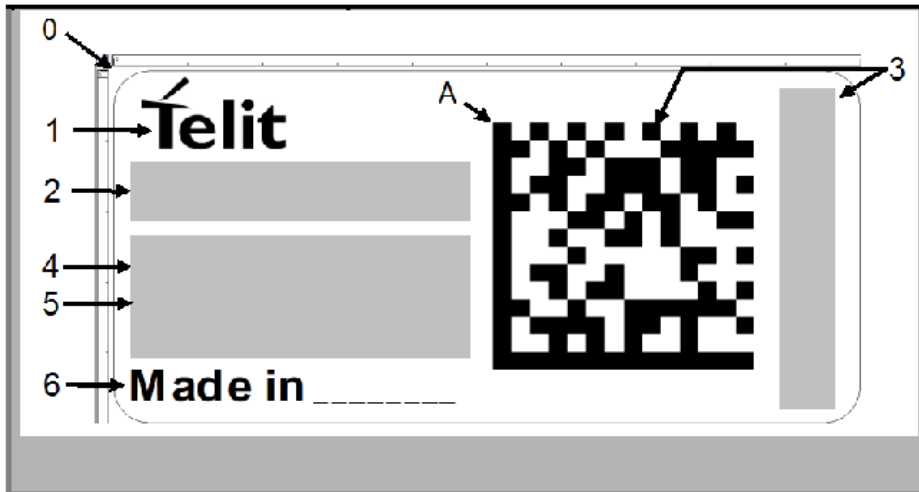

Figure 13-1 SL876Q5-A Product Label

Key	Description
0	Pin 1 location
1	Telit Logo
2	Module Name
3	Telit Serial Number (Barcode type 2D Datamatrix and text)
4	Reserved for Product Variant
5	Certification mark
6	Production Country

Table 13-1 SL876Q5-A Product Label Description

13.2. Product Packaging

SL876Q5-A modules are supplied in Tray packaging of 90 pcs as shown below

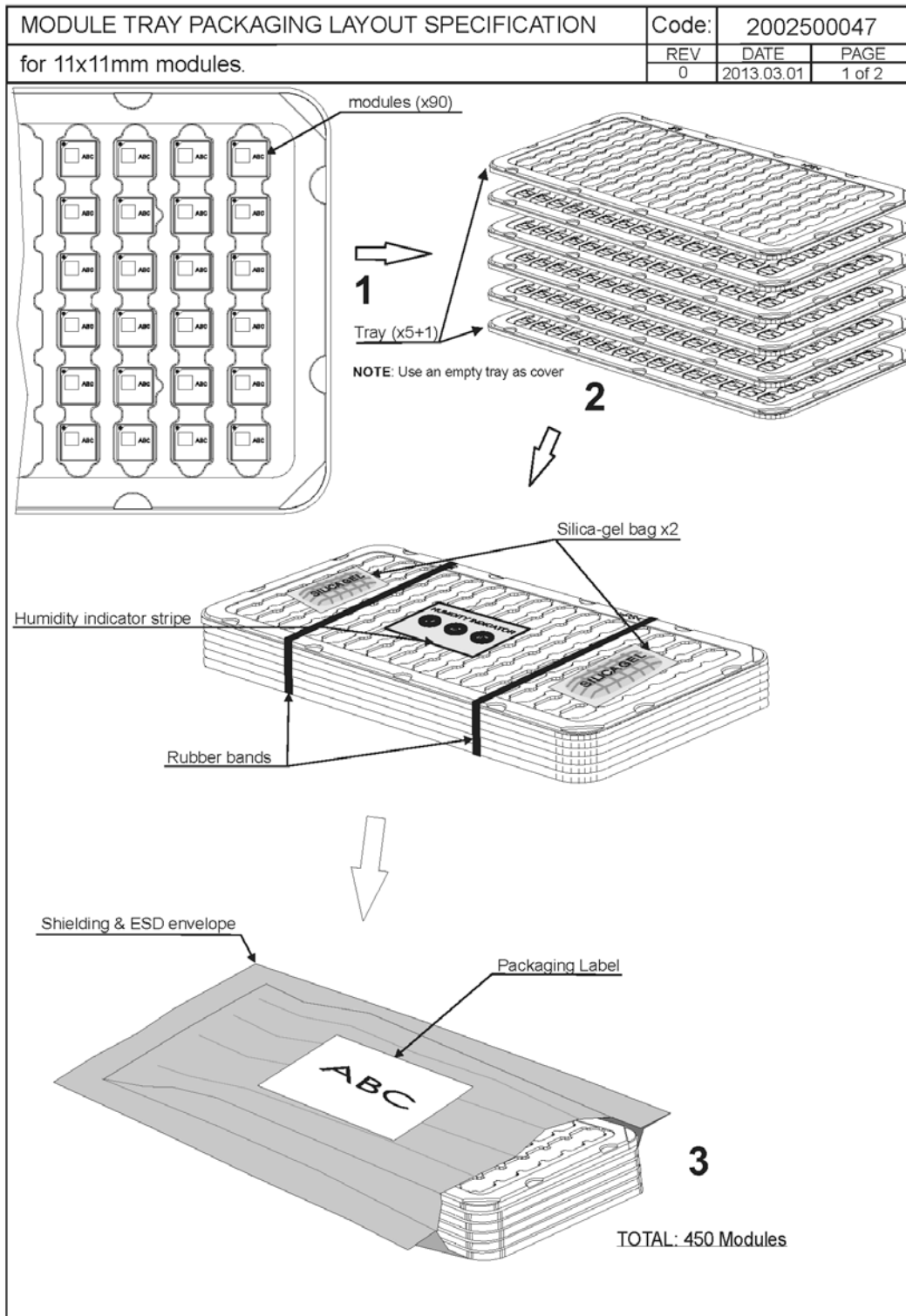

Figure 13-2 Product Packaging – Tray 90 pcs. each

13.3. Moisture Sensitivity

Precautionary measures are required in handling, storing and using these devices to avoid damage from moisture absorption. If localized heating is required to rework or repair the device, precautionary methods are required to avoid exposure to solder reflow temperatures that can result in performance degradation.

The SL876Q5-A module has a moisture sensitivity level rating of 3 as defined by **IPC/JEDEC J-STD-020**. This rating is assigned due to some of the components used within the module.

The SL876Q5-A packaging is hermetically sealed with desiccant and humidity indicator card. The SL876Q5-A parts must be placed and reflowed within 168 hours of first opening the hermetic seal provided the factory conditions are less than 30°C and less than 60% and the humidity indicator card indicates less than 10% relative humidity.

If the package has been opened or the humidity indicator card indicates above 10%, then the parts must be baked prior to reflow. The parts may be baked at $+125^{\circ}\text{C} \pm 5^{\circ}\text{C}$ for 48 hours. However, the tape and reel cannot withstand that temperature. Lower temperature baking is feasible if the humidity level is low and time is available. Please see **IPC/JEDEC J-STD-033** for additional information.

Additional information can be found on the MSL tag affixed to the outside of the hermetically sealed bag.

JEDEC standards are available free of charge from the JEDEC website <http://www.jedec.org>.

	<p>CAUTION</p> <p>This bag contains MOISTURE-SENSITIVE DEVICES</p>	<p>LEVEL</p> <div style="border: 1px solid black; padding: 5px; display: inline-block; font-size: 2em; font-weight: bold;">3</div> <p>If Blank, see adjacent bar code label</p>
<p>1. Calculated shelf life in sealed bag: 12 months at $< 40^{\circ}\text{C}$ and $< 90\%$ relative humidity (RH)</p> <p>2. Peak package body temperature: _____ $^{\circ}\text{C}$ If Blank, see adjacent bar code label</p> <p>3. After bag is opened, devices that will be subjected to reflow solder or other high temperature process must</p> <p style="margin-left: 20px;">a) Mounted within: <u>168</u> hours of factory If Blank, see adjacent bar code label</p> <p style="margin-left: 40px;">conditions $\leq 30^{\circ}\text{C}/60\%$</p> <p style="margin-left: 20px;">b) stored at $<10\%$ RH</p> <p>4. Devices require bake, before mounting, if:</p> <p style="margin-left: 20px;">a) Humidity Indicator Card is $> 10\%$ when read at $23 \pm 5^{\circ}\text{C}$</p> <p style="margin-left: 20px;">b) 3a or 3b not met.</p> <p>5. If baking is required, devices may be baked for 48 hours at $125 \pm 5^{\circ}\text{C}$</p> <p style="margin-left: 20px;">Note: If device containers cannot be subjected to high temperature or shorter bake times are desired, reference IPC/JEDEC J-STD-033 for bake procedure</p> <p>Bag Seal Date: _____ If Blank, see adjacent bar code label</p> <p style="margin-left: 20px;">Note: Level and body temperature defined by IPC/JEDEC J-STD-020</p>		

Figure 13-3 Moisture-Sensitive Device Label

13.4. ESD Sensitivity

The SL876Q5-A module contains class 1 devices and is classified as Electro-Static Discharge Sensitive (ESDS).

Telit recommends the two basic principles of protecting ESD devices from damage:

Handle sensitive components only in an ESD Protected Area (EPA) under protected and controlled conditions;

Protect sensitive devices outside the EPA using ESD protective packaging.

All personnel handling ESDS devices have the responsibility to be aware of the ESD threat to the reliability of electronic products.

Further information can be obtained from the JEDEC standard JESD625-A Requirements for Handling Electrostatic Discharge Sensitive (ESDS) Devices.

13.5. Reflow

The modules are compatible with lead free soldering processes as defined in **IPC/JEDEC J-STD-020**. The reflow profile must not exceed the profile given **IPC/JEDEC J-STD-020** Table 5-2, "Classification Reflow Profiles". Although **IPC/JEDEC J-STD-020** allows for three reflows, the assembly process for the module uses one of those profiles, therefore the module is limited to two reflows.

When re-flowing a dual-sided SMT board, it is important to reflow the side containing the module last. This prevents heavier components within the module from becoming dislodged if the solder reaches liquidus temperature while the module is inverted.

Note: JEDEC standards are available free from the JEDEC website <http://www.jedec.org>.

13.6. Assembly Considerations

During board assembly and singulation process steps, pay careful attention to unwanted vibrations, resonances and mechanical shocks introduced by the board router.

13.7. Washing Considerations

The module can be washed using standard PCB cleaning procedures after assembly. The shield does not provide a water seal to the internal components of the module, so it is important that the module be thoroughly dried prior to use by blowing excess water and then baking the module to drive residual moisture out. Depending upon the board cleaning equipment, the drying cycle may not be sufficient to thoroughly dry the module, so additional steps may need to be taken. Exact process details will need to be determined by the type of washing equipment as well as other components on the board to which the module is attached. The module itself can withstand standard JEDEC baking procedures.

13.8. Safety

Improper handling and use of this module can cause permanent damage to it. There is also the possible risk of personal injury from mechanical trauma or choking hazard.

See **Section 17 Safety Recommendations** for safety information.

13.9. Disposal

We recommend that this product should not be treated as household waste. For more detailed information about recycling this product, please contact your local waste management authority or the reseller from whom you purchased the product.

14. ENVIRONMENTAL REQUIREMENTS

14.1. Operating Environmental Limits

Environmental Limits - Operating	
Temperature	-40°C to +85°C
Temperature Rate of Change	±1°C / minute maximum
Humidity	Up to 95% non-condensing or wet bulb temperature of +35°C, whichever is less
Altitude	-500 m to 18,000 m (Software / ITAR restriction)
Maximum Vehicle Dynamics	514 m/s (acquisition and navigation) 2 G acceleration (Software / ITAR restriction)

Table 14-1 Operating Environmental Limits

14.2. Storage Environmental Limits

Environmental Limits - Storage	
Temperature	-40°C to +85°C
Humidity	Up to 95% non-condensing or wet bulb temperature of +35°C, whichever is less
Altitude	-500 m to 18,000 m (Software / ITAR restriction)
Shock	18G peak, 5 millisecond duration
Shock (in shipping container)	10 drops from 75 cm onto concrete floor

Table 14-2 Storage Environmental Limits

15. COMPLIANCES

The module complies with the following:

- Directive 2002/95/EC on the restriction of the use of certain hazardous substances in electrical and electronic equipment (RoHS)
- Manufactured in an ISO 9000: 2000 accredited facility
- Manufactured to TS 16949 requirement (upon request)

15.1. EU Declaration of Conformity

Certificate in process

15.2. RoHS Certificate

The Telit SL876Q5-A modules are fully compliant with the EU RoHS Directives.

16. GLOSSARY AND ACRONYMS

AGPS	<p>Assisted (or Aided) GPS</p> <p>AGPS provides ephemeris data to the receiver to allow faster cold start times than would be possible using only broadcast data. This extended ephemeris data could be either server-generated or locally-generated.</p> <p>See Local Ephemeris prediction data and Server-based Ephemeris prediction data</p>
Almanac	<p>A reduced-precision set of orbital parameters for the entire GPS constellation that allows calculation of approximate satellite positions and velocities. The almanac may be used by a receiver to determine satellite visibility as an aid during acquisition of satellite signals. The almanac is updated weekly by the Master Control Station. See Ephemeris.</p>
BeiDou (BDS / formerly COMPASS)	<p>The Chinese GNSS, currently being expanded towards full operational capability.</p>
Cold Start	<p>A cold start occurs when a receiver begins operation with unknown position, time, and ephemeris data, typically when it is powered up after a period on inactivity. Almanac information may be used to identify previously visible satellites and their approximate positions. See Restart.</p>
Cold Start Acquisition Sensitivity	<p>The lowest signal level at which a GNSS receiver is able to reliably acquire satellite signals and calculate a navigation solution from a Cold Start. Cold start acquisition sensitivity is limited by the data decoding threshold of the satellite messages.</p>
EGNOS	<p>European Geostationary Navigation Overlay Service</p> <p>The European SBAS system.</p>
Ephemeris (plural ephemerides)	<p>A set of precise orbital parameters that is used by a GNSS receiver to calculate satellite position and velocity. The satellite position is then used to calculate the navigation solution. Ephemeris data is updated frequently (normally every 2 hours for GPS) to maintain the accuracy of the position calculation. See Almanac.</p>
ESD:	<p>Electro-Static Discharge</p> <p>Large, momentary, unwanted electrical currents that can cause damage to electronic equipment.</p>
GAGAN	<p>The Indian SBAS system.</p>
Galileo	<p>The European GNSS currently being built by the European Union (EU) and European Space Agency (ESA).</p>
GDOP	<p>Geometric Dilution of Precision</p> <p>A factor used to describe the effect of satellite geometry on the accuracy of the time and position solution of a GNSS receiver. A lower value of GDOP indicates a smaller error in the solution. Related factors include PDOP, HDOP, VDOP and TDOP.</p>
GLONASS	<p>ГЛОБАЛЬНАЯ НАВИГАЦИОННАЯ СПУТНИКОВАЯ СИСТЕМА</p> <p>GLOBal'naya NAvigatsionnaya Sputnikovaya Sistema</p> <p>(Global Navigation Satellite System)</p> <p>The Russian GNSS, which is operated by the Russian Aerospace Defense Forces</p>
GNSS	<p>Global Navigation Satellite System</p> <p>Generic term for a satellite-based navigation system with global coverage. The current or planned systems are: GPS, GLONASS, BDS, and Galileo.</p>

GPS	Global Positioning System The U.S. GNSS, a satellite-based positioning system that provides accurate position, velocity, and time data. GPS is operated by the US Department of Defense.
Hot Start	A hot start occurs when a receiver begins operation with known time, position, and ephemeris data, typically after being sent a restart command. See Restart.
LCC	Leadless Chip Carrier A module design without pins. In place of the pins are pads of bare gold-plated copper that are soldered to the printed circuit board.
LNA	Low Noise Amplifier An electronic amplifier used for very weak signals which is especially designed to add very little noise to the amplified signal.
Local Ephemeris prediction data	Extended Ephemeris (i.e. predicted) data, calculated by the receiver from broadcast data received from satellites, which is stored in memory. It is usually useful for up to three days. See AGPS.
MSAS	MTSAT Satellite Augmentation System The Japanese SBAS system.
MSD	Moisture sensitive device.
MTSAT	Multifunctional Transport Satellites The Japanese system of geosynchronous satellites used for weather and aviation control.
Navigation Sensitivity	The lowest signal level at which a GNSS receiver is able to reliably maintain navigation after the satellite signals have been acquired.
NMEA	National Marine Electronics Association
QZSS	Quasi-Zenith Satellite System The Japanese SBAS system (part of MSAS).
Reacquisition	A receiver, while in normal operation, loses RF signal (perhaps due to the antenna cable being disconnected or a vehicle entering a tunnel), and re-establishes a valid fix after the signal is restored. Contrast with Reset and Restart.
Restart	A receiver beginning operation after being sent a restart command, generally used for testing rather than normal operation. A restart can also result from a power-up. See Cold Start, Warm Start, and Hot Start. Contrast with Reset and Reacquisition.
Reset	A receiver beginning operation after a (hardware) reset signal on a pin, generally used for testing rather than normal operation. Contrast with Restart and Reacquisition.
RoHS	The Restriction of Hazardous Substances Directive on the restriction of the use of certain hazardous substances in electrical and electronic equipment, was adopted in February 2003 by the European Union.
RTC	Real Time Clock An electronic device (chip) that maintains time continuously while powered up.
SAW	Surface Acoustic Wave filter Electromechanical device used in radio frequency applications. SAW filters are useful at frequencies up to 3 GHz.

SBAS	<p>Satellite Based Augmentation System</p> <p>A system that uses a network of ground stations and geostationary satellites to provide differential corrections to GNSS receivers. These corrections are transmitted on the same frequency as navigation signals, so the receiver can use the same front-end design to process them. Current examples are WAAS, EGNOS, MSAS, and GAGAN.</p>
Server-based Ephemeris prediction data	<p>Extended Ephemeris (i.e. predicted) data, calculated by a server and provided to the receiver over a network. It is usually useful for up to 14 days. See AGPS.</p>
TCXO	<p>Temperature-Compensated Crystal Oscillator</p>
Tracking Sensitivity	<p>The lowest signal level at which a GNSS receiver is able to maintain tracking of a satellite signal after acquisition is complete.</p>
TTF	<p>Time to First Fix</p> <p>The elapsed time required by a receiver to achieve a valid position solution from a specified starting condition. This value will vary with the operating state of the receiver, the length of time since the last position fix, the location of the last fix, and the specific receiver design.</p> <p>A standard reference level of -130 dBm is used for testing.</p>
UART	<p>Universal Asynchronous Receiver/Transmitter</p> <p>An integrated circuit (or part thereof) which provides a serial communication port for a computer or peripheral device.</p>
WAAS	<p>Wide Area Augmentation System</p> <p>The North American SBAS system developed by the US FAA (Federal Aviation Administration).</p>
Warm Start	<p>A warm start occurs when a receiver begins operation with known (at least approximately) time and position, but unknown ephemeris data, typically after being sent a restart command. See Restart.</p>

17. SAFETY RECOMMENDATIONS

17.1. READ CAREFULLY

Be sure that the use of this product is allowed in the country and in the environment required. The use of this product may be dangerous and must be avoided in the following areas:

- Where it can interfere with other electronic devices in environments such as hospitals, airports, aircraft, etc.
- Where there is risk of explosion such as gasoline stations, oil refineries, etc. It is the responsibility of the user to enforce the country regulations and specific environmental regulations.

Do not disassemble the product. Evidence of tampering will invalidate the warranty.

Telit recommends following the instructions in product user guides for correct installation of the product. The product must be supplied with a stabilized voltage source and all wiring must conform to security and fire prevention regulations. The product must be handled with care, avoiding any contact with the pins because electrostatic discharges may damage the product itself.

The system integrator is responsible for the functioning of the final product; therefore, care must be taken with components external to the module, as well as for any project or installation issue. Should there be any doubt, please refer to the technical documentation and the regulations in force. Non-antenna modules must be equipped with a proper antenna with specific characteristics.

The European Community provides directives for electronic equipment introduced in the market. Relevant information is available on the European Community website:

<http://ec.europa.eu/enterprise/sectors/rtte/documents/>

The text of the Directive 99/05 regarding telecommunication equipment is available, while the applicable Directives (Low Voltage and EMC) are available at:

<http://ec.europa.eu/enterprise/sectors/electrical/>

The power supply used shall comply the clause 2.5 (Limited power sources) of the standard EN 60950-1 and shall be mounted on a PCB which complies with V-0 flammability class.

Since the module must be built-in to a system, it is intended only for installation in a RESTRICTED ACCESS LOCATION. Therefore, the system integrator must provide an enclosure which protects against fire, electrical shock, and mechanical shock in accordance with relevant standards.

<http://ec.europa.eu/enterprise/sectors/electrical/>

17.2. Electrical and Fire Safety

This device is intended for built-in designs and must be installed by users that have taken adequate precautions and have sufficient knowledge to avoid electrical, mechanical and fire hazards.

The module shall be mounted on a PCB which complies with V-0 flammability class.

The device must be supplied with a limited power source that meets clause 2.5 of the EN 60950-1 standard. These requirements are:

- For power supplies without overcurrent protection device:
Short circuit current < 8 A. Apparent power < 100 VA
-
- For power supplies with overcurrent protection device (rated current of overcurrent device shall be < 5 A):
Short circuit current < 333 A. Apparent power < 250 VA.
-
- Furthermore, the device must be installed within an enclosure that meets HB class or pass the 550° glowing fire test of EN 60695-2-11 and mounted on a V1 flammability class material or better.

18. DOCUMENT HISTORY

Revision	Date	Changes
0	2017-03-02	Initial issue
1	2017-06-21	Added ground plane information Minor text revisions and additions
2	2017-06-27	Removed "Preliminary" watermark



SUPPORT INQUIRIES

Link to www.telit.com and contact our technical support team for any questions related to technical issues.

www.telit.com



Telit Communications S.p.A.
Via Stazione di Prosecco, 5/B
I-34010 Sgonico (Trieste), Italy

Telit Wireless Solutions Inc.
3131 RDU Center Drive, Suite 135
Morrisville, NC 27560, USA

Telit Wireless Solutions Ltd.
10 Habarzel St.
Tel Aviv 69710, Israel

Telit IoT Platforms LLC
5300 Broken Sound Blvd, Suite 150
Boca Raton, FL 33487, USA

Telit Wireless Solutions Co., Ltd.
8th Fl., Shinyoung Securities Bld.
6, Gukjegeumyung-ro8-gil, Yeongdeungpo-gu
Seoul, 150-884, Korea

Telit Wireless Solutions
Tecnologia e Servicos Ltda
Avenida Paulista, 1776, Room 10.C
01310-921 São Paulo, Brazil

Telit reserves all rights to this document and the information contained herein. Products, names, logos and designs described herein may in whole or in part be subject to intellectual property rights. The information contained herein is provided "as is". No warranty of any kind, either express or implied, is made in relation to the accuracy, reliability, fitness for a particular purpose or content of this document. This document may be revised by Telit at any time. For most recent documents, please visit www.telit.com

Copyright © 2016, Telit